

SENCOR®

Let's live!

**INTERNET RADIO
SIR 5000WDB**

**USER'S MANUAL
EN**





Table of Contents

Table of Contents.....	1
Safety Instructions.....	2
Appearance and Key Description	4
Front View.....	4
Top View.....	5
Back View	5
Getting Started	8
Get the network ready.....	8
With Remote Control	10
AirMusic Control App.....	12
Main Menu	13
My mediaU.....	13
Internet Radio.....	14
My Favorite.....	14
Radio Station/Music.....	15
History.....	15
Service	15
Media Center	16
FM.....	17
DAB/DAB+	17
Information Center	18
Bluetooth.....	19
Configuration	20
About Music Streaming.....	30
UPnP.....	30
DLNA.....	30
Troubleshooting	32
Technical Specifications.....	34
WiFi Internet Radio SIR 5000WDB.....	34
INSTRUCTIONS AND INFORMATION REGARDING THE DISPOSAL OF USED PACKAGING MATERIALS	36
DISPOSAL OF USED ELECTRICAL AND ELECTRONIC APPLIANCES.....	36

Safety Instructions

This product has been designed with the utmost safety in mind. However, incorrect use may lead to electric shock or fire. This is why users should observe the following instructions when using this device.

This device uses a semiconductor unit and contains no user serviceable parts. Do not disassemble this device, otherwise you are exposed to the risk of electric shock. If any damage to this product occurs, please have this product repaired by a qualified service technician.

Power source

Power supply of this unit must be match the serial plate data.

Heat source

Keep this unit out of heat sources like stove or direct sunlight.

Cleaning

Prior to cleaning, please disconnect power first. For cleaning, don't use liquid detergents or caustic liquids - just clean the unit with a soft cloth.

Heavy objects

Do not place heavy objects on the unit, otherwise damage might occur.

Connecting other devices

Before connecting other devices to this unit, please make sure to disconnect power. Otherwise damage to the unit or personal injury might occur.

Faults to be repaired

If any of the following problems occurs, please disconnect power to the unit and contact a qualified service technician.

- A. Power cord or plug is damaged.
- B. Liquids or other foreign objects have penetrated inside the product.

- C. If the unit does not work even if it's being operated according to the instructions, don't press any buttons other than those described in these instructions. Otherwise, damage to this unit may occur along with a more demanding repair.
- D. This unit has fallen on the ground from a big height.
- E. Burns can be smelled from the product inside.

Maintenance

If you don't have enough technical knowledge necessary to maintain this unit, don't attempt to repair it by yourself. By removing cover, you are exposed to a risk of electric shock. If needed, please contact a qualified service technician.

Replacement of parts

If you need to replace any part of this unit, ask your service technician to make a replacement for equal spare part models. If other spare part models are used for replacement, serious damage, electric shock or shortening the unit's lifetime may occur.

Safety check

When done with the maintenance, ask your service technician to perform an on-site safety check to make sure that the unit's operation is safe.



Note:

Before using this product, read these instructions carefully and keep it well for future use.

Appearance and Key Description

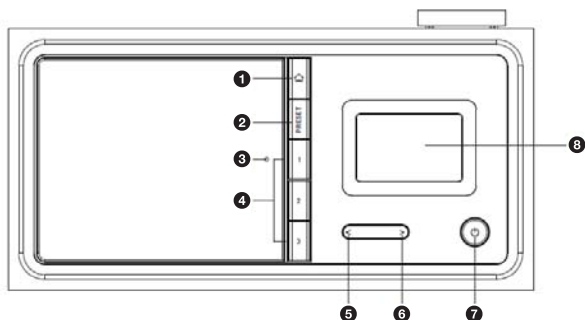
Front View



- 1**  Button
Press to return to the main menu
- 2** PRESET button
Press and hold to save the stations.
- 3** Remote control sensor
- 4** Preset 1, 2, 3
- 5** < Left cursor / Previous button
- 6** > Right cursor / Next button
- 7**  Power on/Standby button
- 8** 2.4" TFT full color display

Top View

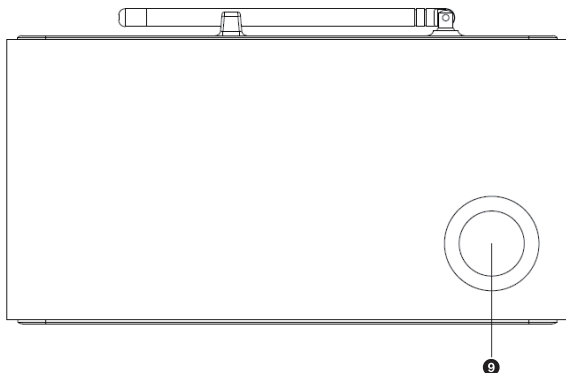

- 9** Volume/Navigate + OK dial
 Turn the knob right to increase volume, turn it left to decrease volume. Move a cursor up/down by turning the knob or press the knob to confirm the selection.

Back View

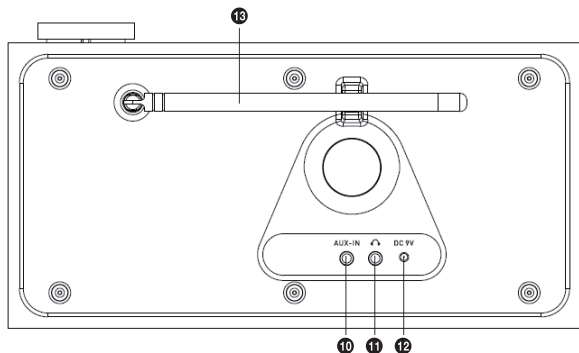

- 10** 3.5mm AUX-IN Jack
11 3.5mm Earphone Jack

- 12 DC 9V Power Jack
- 13 Telescopic Antenna

Remote Control

- 1 Power on/Standby button
- 2 INFO button
- 3 Home Button
Press to return to the main menu.
- 4 Play/Pause button
- 5 Sleep button
- 6 button
Press to skip to previous track
- 7 < Left cursor button
- 8 OK button
- 9 button
Press to skip to next track
- 10 PRESET button
- 11 0~9 call up favorites/
memory;
Input letters and numbers
- 12 Mute button
- 13 PRESET button
- 14 MODE button
- 15 ALARM button
- 16 TIMER button
- 17 Increase volume button
- 18 ^ Up cursor button
- 19 > Right cursor button
- 20 v Down cursor button
- 21 Decrease volume button
- 22 EQ button

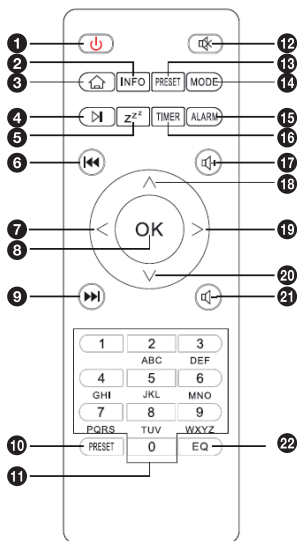











To remove the battery from the remote, use your thumb to pull out the battery tray.

Replace it with a two AAA type battery.

**Caution:**

Risk of explosion of battery is replaced by an incorrect type.
Dispose of used batteries according to the instructions.

Symbols on the display

-  Connection is being established, device functioning
-  No wireless connection
-  Wireless connection established
-  Search
-  VHF radio function selected
-  VHF radio reception: Mono
-  VHF radio reception: Stereo
-  Speaker off
-  Alarm on
-  Internet radio station saved as favorite
-  FM radio station saved

Getting Started

The packaging box contains the following items:

SIR 5000WDB Internet Radio

Remote Control

Power Adapter

User Manual

Get the network ready

- For wireless LAN(WLAN) network connection:
Check if WLAN LINK/ACT light of the wired/wireless access point or router is illuminated. Consult the user guide of that for any questions.

Note:



WiFi allows data transfer over short distances within 20 meters without the need of cabling between the devices. Any walls or ceilings may reduce the strength of the WiFi connectivity.

Therefore try to locate the Internet Radio and/or the access point within the distance mentioned above, and avoid any obstacles between two devices.

- Insert DC jack of the power adapter into the DC jack and Plug the another end into the AC socket.
- When it is the first time running the device, the system will ask you to set **Language** and **Network Configurations**.

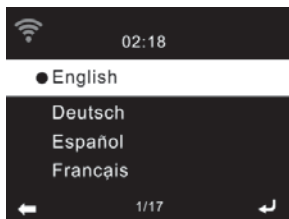

Menu/Configuration/Language

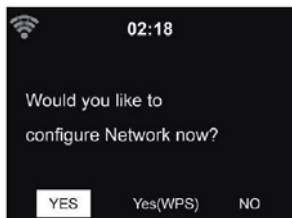
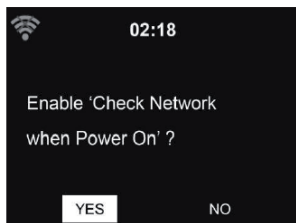

- Select Yes to establish connection to the network.
- Select Yes (WPS) only for WPS routers. Then press the WPS button on your router.
- Select No if you would prefer to listen to a terrestrial station or to use the speaker with an external playback device. If you answer "Yes", the display goes to scanning for Wireless Network and shortly afterwards a list of available wireless networks will appear.

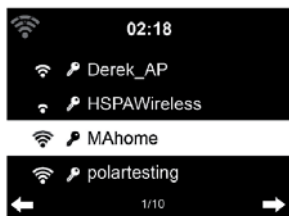

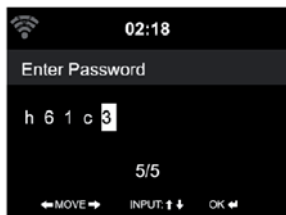

The number of bars in the wireless symbol in front of the network name (SSID) shows the relative signal strength of the network.

The key symbol indicated that the network is password-protected.

If the device does not find any wireless networks, no wireless Networks Found appears on the display. Change your location, if necessary, and check your WLAN router.

You can find the SSID of your Access Point in the configuration of the Access Point (router).

Select your network and confirm with **OK**. If your WLAN is password-protected, you will be prompted to enter your password. Enter the password using the number and letter buttons of the remote control or enter it directly on the device (you can rotate the Volume/Navigate reel on the top of the device to choose the code). If it is accidentally pressed > to set a number/letter, you can press < to correct the record.

Note the use of upper and lower case when entering the password.

With Remote Control

The cursor indicates the current entry space.

Press the corresponding number button repeatedly:

- 0 0
- 1 (space and special symbols)
- 2 A B C a b c
- 3 D E F d e f
- 4 G H I g h i
- 5 J K L j k l
- 6 M N O m n o

- 7 P Q R S p q r s
 8 T U V t u v
 9 W X Y Z w x y z

Alternatively, you can rotate the Volume/Navigate + OK dial **to choose** the numbers and letters:

- < Go to previous entry space, entry can be overwritten
- > Go to next entry space, the last entry is saved.

After you have entered the final number/letter, you should press the Volume/Navigate + OK dial to confirm, then the display will show as below:

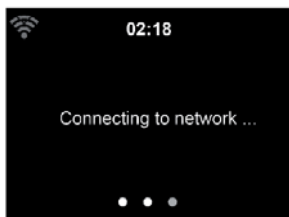

It may take a few seconds to establish the connection to the network. Once the connection is established, the main menu appears with the main menu items:

- Internet Radio: Access to worldwide radio stations
- Media Center: Access to your UpnP devices via software with streaming capability.
- FM: Access to FM radio stations
- DAB: Access to DAB radio stations
- Information Center: Access to weather, financial and system information.
- AUX : Access to all devices connected via 3.5mm Aux-in cable.
- Bluetooth: Access to all devices connected via bluetooth.
- Configuration: Various system settings
- Local Radio: Access to radio stations in a particular region (e.g. only German Stations)
- Press  to enter standby mode. The time, date and any active alarm times display on the screen.



- If you have setup a network connection, and use the device again within the network, it will automatically establish the connection. In case you desire to change the network, enter **Configuration** to setup the corresponding connection. If you have more AP with the same SSID at home, you can manually select the one with the strongest signal.

AirMusic Control App

The device can be controlled with your smartphone via WiFi. It is recommended to use the AirMusic Control App. Additionally to controlling the radio, the app is able to play the smartphone's local music files on the device.

The app itself is available for Android and iOS. It can be downloaded from here:

Android:



Apple iOS:



Main Menu

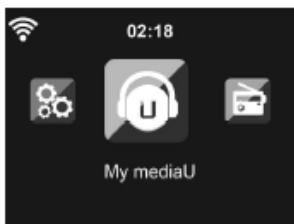

In the main menu you can select the following modes, Local Radio, My mediaU (if it is enabled), Internet Radio, Media Center, FM, Information Center, AUX, Bluetooth, and Configuration.

My mediaU

Display and playback your own mediaU station list on the mediaU server. Set your account first.

When it is enabled, My mediaU will be shown on the main menu.

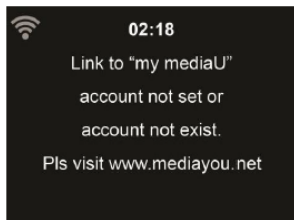

To activate your own station list, follow the steps below:

1. Access <http://www.mediayou.net>.
2. Join my mediaU membership
3. Login to the website
4. Enter the wireless MAC address of the device to the mediaU website. This information can be obtained in **Information Center > System Information > Wireless Info**

- After successfully configuring, you are able to save and view your own mediaU station playlist(s). Username and password are not required to enter to the device.

Each time you have made any updates on the playlist from the website, go to Configuration > Manage my MediaU > Enable to synchronize the change to the device.

Internet Radio

After connecting any station, the bit rate and the format of the station are displayed on the playing screen.

Note:

The quality and availability of all internet radio stations can not be guaranteed.

My Favorite

Create a list of your favorite preset stations.

During the station playing screen, press and hold **Preset** on the device to save the station as my favorite. You may replace the previous saved station to the new one.

You also can save the station to your favorite while scrolling through the station list. When the station is highlighted you can press > to enter this menu where you can add the station to your favorites.



If the selected station has been saved, you can't save it again.

Under the preset station list, move to your station, press **OK** to listen. You may also press > to enter its submenu to **Delete**, **Shift Up**, **Shift Down** along the list, **Rename** or **Play**.

Radio Station/Music



Stations are categorized into **Global Top 20**, **Genre**, **Country/Location** and **Highlight**. Enter to continue the subcategories and choose the station to listen.

For each station, press **OK** to play directly. You may press > to enter its submenu. You can **Add to Favorites**, **Auto Scan** or **Play**.

When you choose Auto Scan, the radio introduces every station in the list by playing it for 30 seconds. This is stopped when every station is played or you press the **OK** button.

History

Show you a list of last listened stations. It can save up to 10 history stations.

For each station, press **OK** to play directly. You may press > to enter its submenu. You can **Add to Favorites**, **Auto Scan** or **Play**.

When you choose Auto Scan, the radio introduces every station in the list by playing it for 30 seconds. This is stopped when every station is played or you press the **OK** button.

Service



Search Radio Station - Enter your keyword by the remote control to search radio station from the list.

Add New Radio Station - The added stations will be stored in My Favorites. Note that the maximum character of the station name is 250.

Media Center

UPnP



If you have set up shared media, you should see the shared media from UpnP. If you have more than one computer sharing media, the alternatives are listed. Select the shared media you want to play.

Press \wedge / \vee on the remote control to play previous/next music track.

Press **▶||** to stop or play.

Press **INFO** on the remote to view the display information of the playing track.

Tips:

The radio can only read the track of file names with less than 40 characters. And the characters should be in European language. If you encounter failure of reading the track under UpnP mode, you may try to rename the file.

However, if the track is still unable to play, you can try converting the file to a different format.

My Playlist

You can create a playlist of favorite music from UpnP. When you play the music, press and hold **OK** to save it into **My Playlist**.

Clear My Playlist

You can remove all the saved music under My Playlist.

FM



FM mode can receive radio stations from the FM band.

Press \langle / \rangle to search for FM stations. The frequency display starts to run up as the device scans the FM band. It stops when it has received a station.

You may press \wedge / \vee on the remote control to tune station manually. Each step moves 0.05MHz.

Press the **PRESET** button on the remote control to save the station. Press \wedge / \vee on the remote control to choose the saved station position.

Alternatively, you can let the system scan ALL stations for you by pressing **OK**, the searched stations will automatically be stored in preset station list.

DAB/DAB+

Press the **MODE** button on the radio or the $\text{house icon} / \text{MODE}$ button on the remote control, and use the \langle / \rangle to select DAB.

DAB Station Scan

When the radio is switched on to DAB mode for the first time, it will

start an automatic station scan in order to scan for all stations that can be received at that location.

The station scan will begin and the display will show a scan progress bar. As soon as the scan has been completed, it will start playing the first station on the station list it finds.

Station selection

While in DAB mode, use the \wedge/\vee buttons to navigate through the DAB+ stations that can be received, press the **OK** to confirm to select a station from the list.

The radio is equipped with a favourites station memory.

Press the **PRESET** button on the remote control to save the station.

Press \wedge/\vee on the remote control to choose the saved station position.

DAB Radio Operation

If you have saved stations in the favourites memory, you can call these up by pressing the desired number key.

Or while in DAB mode press the **Preset** button to call up the favourites list.

Use the \wedge/\vee button on the radio or remote control to navigate through the favourites list, then press **OK /Volume Knob** to confirm your selection to play the station.

Information Center

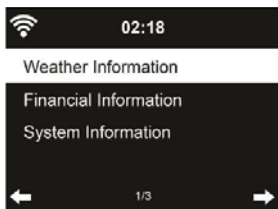

Weather Information

There are weather information and forecasts for 5000 cities. Select the country and then the city for the weather details.



Press \wedge/\vee to see the weather forecasts.
It is able to display the weather information on the standby mode.
On the weather information page, press **OK** to set the city to displaying on the standby mode.

Financial Information

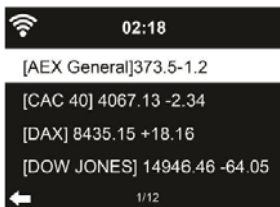

View the stock index from around the world.

System Information

Check out the version of the system, and the details of connected network.

Bluetooth

- Press home button on the device or home / **MODE** button on the remote control, and use "< / >" to select **Bluetooth**, then you can hear the sound "pairing" to pair.
- Turn on Bluetooth on your external device and check the visible devices. Select the device name "**SIR5000WDB**" from the list of found devices and pair the devices.

Tips:

Only one playback unit can be connected to the speaker. If the speaker is already connected to another playback unit, the speaker will not appear in the Bluetooth selection list.

- If your external device asks for a passkey (depending on the device manufacturers, model, and software version), then enter digits "0000" (four zeros) and press OK.
If pairing has been carried out successfully, a sound "Connected" can be heard.
- After connected completely, you can listen to music wirelessly through Bluetooth and select music in Bluetooth external device.
- Short press ►|| button on the device or remote control to pause or resume playback.
Press < / > button on the device or remote control to skip to next/previous track.

Attention: Some connected devices can support an undivided volume settings. If one of the connected devices do not support this function then the volume adjustment will work on both devices separately.

Configuration

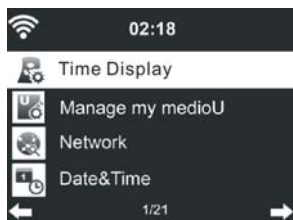

Time Display

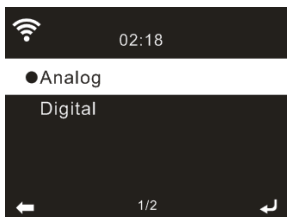

You may choose the standby display with **Analog** or **Digital**.

Manage my mediaU

When it is enabled, My mediaU will be shown on the main menu. If various mediaU accounts exist in the device, select the default login account in here. Refer to 6.1 for more information of mediaU account setup.

Network

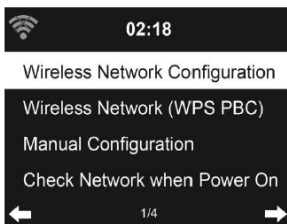

Wireless Network Configuration

Select your required AP wireless network.

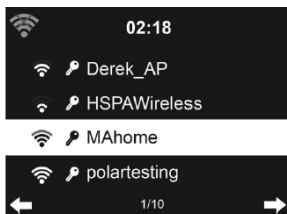

Enter WEP or WPA/WPA 2 code to connect the WiFi.

If it is accidentally pressed > to set a number/letter, you can press < to correct the record.

Wireless Network (WPS PBC)

If you are using a router with WPS/QSS button, you may set up the network connection simple via WPS function. Enter it and go to press the WPS/QSS button on your router within 120 seconds. The connection between the router and the device will then be configured automatically.

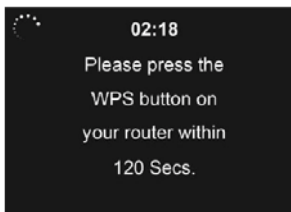

Manual Configuration

You can choose DHCP (which IP assigned automatically) or manually input IP address for wireless network connection.

When you select manual setting for wireless connection, the followings have to be entered:

1. IP Address
2. Subnet Mask
3. Default Gateway
4. Preferred DNS Server
5. Alternate DNS Server

You may choose (Manage) specific network if you have setup more than one network connection within an area.

If you have more than one network connection fill in the SSID (the name of Access Point) and password. It will automatically connect to the network.

Check Network when Power On

"Enable / disable WiFi network":

When you enable the WiFi network, the system will automatically search the available AP.

Select your required AP.

Enter WEP or WPA/WPA 2 code to connect the WiFi.

If the wireless network connection is not existed or failed, the icon at the top left corner will have a cross on it.

Date & Time

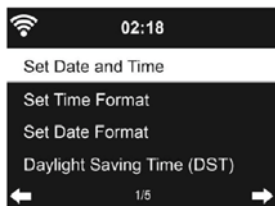

- Setup the date and time
- Set time format display as 12 Hour or 24 Hour (default).
- Set date format in the positions of **YY** (year), **MM** (month) and **DD** (day) – YY/MM/DD, DD/MM/YY (default) or MM/DD/YY.
- Turn on/off (default) the Daylight Saving Time (DST).

Note:

With a wireless network connected, you can use a time and date presetting based on an Auto detect function. In the Auto detect function a GMT (+00:00) time is a time reference of time setting. Then go to Manual date and time settings and add or reduce the hour according to your time zone when you set the time.

Alarm



There are three independent alarms – 2 alarms of absolute time setting (**Alarm 1** and **Alarm 2**) and 1 alarm for relative time setting (NAP Alarm). Press **Alarm** on the remote control to enter this menu directly.

The first two alarms are similar to the normal alarm. Turn it on then set the time and set it alarms every day, once or every specific day of week. Choose Sound to set the sound to Beep, Melody or Internet Radio.

Note that the alarm source is from preset internet radio if Alarm Sound is set to Internet Radio. It can only set one station for both alarms. When it reaches the alarm time, the device connects to the internet if the set network is available. Therefore there may be some delay from the alarm to the radio play. If no network is connection in one minute, the alarm will change to Melody automatically.

When **Alarm NAP** is set, it alarms once 5/10/20/30/60/90/120 minutes depending on which one you have set.

You may choose **Alarm Volume** to configure the volume of the alarms.



When the alarm(s) is/are set, there will be a clock icon at the top of the display. The clock icon with alarm time will also clearly display on the standby mode screen.

When the alarm time is reached, the volume of sound increases repeatedly until the alarm is stopped by the user.

During alarm, press any key to enter snooze mode. It will alarm again in 5 minutes. Press the  button to stop the alarm.

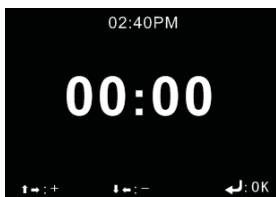
Timer



Press    on the remote control to setup the timer, then press **OK** to confirm.

Language

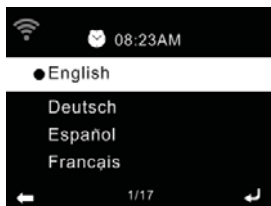

Select the OSD language: English, German, Czech, Polish, Hungarian and so on.

Dimmer

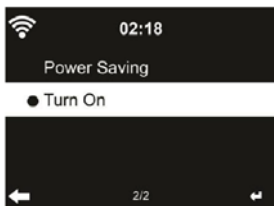

Configure the brightness of backlight on the display. If you select Power Saving, you can select the level to which the display is dimmed down when the radio enters the standby mode or when the radio gets no key input for 15 seconds. The Turn On options keep the display illumination always. If you select it you can choose how bright the display shall be.

Display

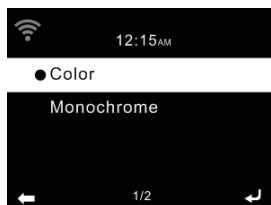

You may choose to set the display in **Color** or **Monochrome**.

Power Management

Choose the power management timer (5/15/30mins) to set the duration of the radio to switch to the standby mode automatically when no network connection is available.

Choose "Turn Off" to ignore the power management function.

Sleep Timer

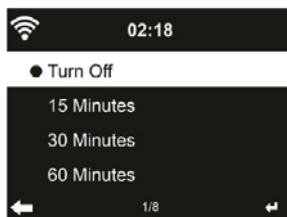

Turn off or set the sleep time to 15/30/60/90/120/150/180 minutes. Once the time is set, there will be a bed icon with remaining minutes at the top right corner. The device will shut down once the time runs out. Press **Zz** on the remote control for the shortcut of this function.

Buffer

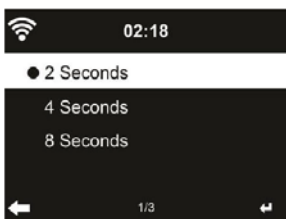

Configure the buffer time of the music playback, 2/4/8 seconds.

Weather

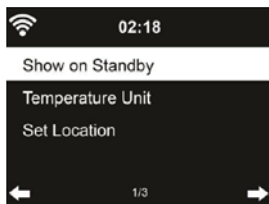

The device is able to display current weather information for a selected location under standby mode. Turn on Standby Display and set Temperature Unit (°C or °F) to get the weather displayed at the standby mode.

When it is turned on, the display will switch between time and weather while being in standby mode.

FM Setup

Choose Mono/Stereo audio output.

Local Radio Setup

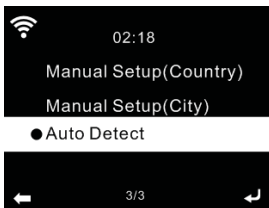

You may **Manual Setup** (Country / City) your location, or let the system **Auto Detect** your current location. The system detects location according to the IP address of your connected network.

Press **Local Radio** to enter this local radio list directly.

Playback Setup

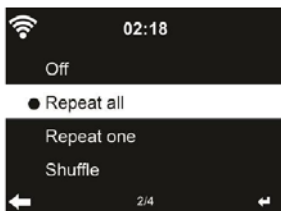

Select the playback mode of media center – **Off** (no repeat or shuffle), **Repeat all**, **Repeat one** or **Shuffle**.

Device

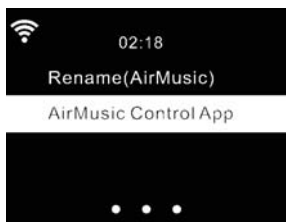

The default device name for DLNA is AirMusic. You may rename it for DLNA setup on the PC or mobile.



You can press AirMusic Control App to enter into QR code scan interface.

Equaliser

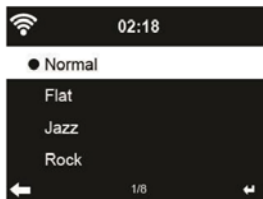

Default equalizer is Normal, you may change to Flat, Jazz, Rock, Soundtracks, Classical, Pop, News.

Press **EQ** on the remote control to swap among the EQ mode for shortcut.

Resume When Power On

The system is default to resume internet radio playback if you were listening to internet radio or media center before switch off the unit. If turn this setting off, the system will remain in the main menu when switching on the unit.

Software Update

If there is an updated software version on the server, the system will inform you.

Reset to Default

Restore the default settings.

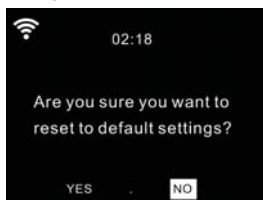

After the device is reset, the system will move to **Language** setting menu. And it will automatically turn to **Network** setting menu once the OSD language is elected.

Local Radio

There is a shortcut Local Radio under Internet Radio so that you can easily go to the station list of your location.

The device can use the IP address to detect its current location and can then automatically generate a list of local radio stations.

About Music Streaming

The device model number is the default device name for DLNA, and you may rename it as you like.

The information below is the introduction of how to setup up media streaming from PC or other media server. Study the own instruction of the software or apps you use to enjoy music streaming if necessary.

Make sure the music files are in the format of MP3, WMA, WAV, FLAC or AAC for music streaming to the device.

UPnP

- To enjoy music streaming from your PC, the following steps are to be done on the PC:
 - Connect the PC to the network
 - Ensure the device is powered on and connected to the same network
 - Open the UPnP platform on PC and allow to share your media to the device. For sharing please use your own software available in your PC or mobile device.
 - Add the audio files and folders you want to share with the device to the media library.

DLNA

Besides UPnP, the device also can support DLNA function. You can share music files from PC or mobile device.

An example of settings for Windows 7:

Firstly share the media on your PC to the device. Go to **Control**

Panel > Network and Internet > Network and Sharing Center > Media streaming options).

Open **Windows Media Player** to enable **Allow remote control of my Player**.

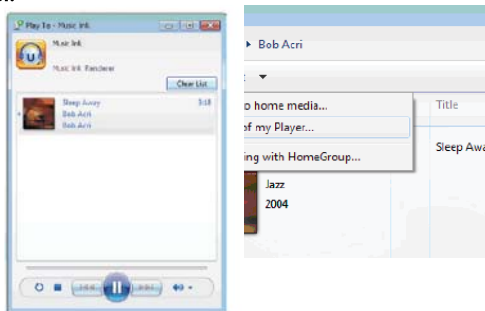

Right click any music in the library and choose Play to the device. There will be a window for controlling music playback on the device.

You may search and install any free or commercial DLNA apps from Google Play or Apple Store. If you are using an Android mobile, tablet or iPhone/iPad.

Some apps may not support streaming music from iPhone/iPod but iPhone/iPod could still be used to control streaming music from other servers.

Troubleshooting

Error	Remedy
No display indication, radio does not respond to operation	1. Set up power supply via mains adapter supplied
No operation via remote control possible	1. Batteries discharged or incorrectly inserted. 2. Please check whether batteries inserted in correct direction.
DAB+ reception poor	1. No stations found, perform a station scan 2. Antenna not fully extended. 3. Change the location of the radio (e.g. closer to window), 4. Repeat station scan
FM reception poor	1. Antenna not fully extended, extend the FM antenna to its full length. 2. Change the location of the radio (e.g. closer to window) 3. Repeat station scan
Poor audio quality when playing music	1. File with low bit rate. Check the audio file. 2. Change the radio station (some radio stations can have a low bit rate).
The device does not switch on.	1. Check if the power adaptor is connected properly.
No sound.	1. Turn on the sound as it may be muted. 2. Increase the volume.
No network connection can be established.	1. Check the WLAN function. 2. Try to set an IP address at the device. 3. Activate the DHCP function on the router and make the connection again at the device. 4. A firewall is activated on the network – set the respective program in such a way that access is possible. 5. Reboot the unit to try.

WLAN connection can't be established	<ol style="list-style-type: none"> 1. Check the availability of WLAN network on the access point. 2. Place the device closer to the router. 3. Make sure the WEP/WPA password is correct.
No station is found.	<ol style="list-style-type: none"> 1. Check the network as well as the access point and firewall. 2. The station may not be available currently, try it again later or select another station. 3. The link of the station is changed or the station no longer transmits – ask the radio station provider for more information. 4. The link of manual added station is not correct, make sure it is correct and re-enter.
Alarm does not work.	<ol style="list-style-type: none"> 1. Switch on the alarm. 2. Due to the volume setting, refer to the solutions of " No sound". 3. The source of alarm was set to be station but there is no network connection. Change the source of alarm or reconfigure the connection.
Unable to do DLNA streaming.	<ol style="list-style-type: none"> 1. Check the connection of the network. The device and your PC or mobile device need to be in the same network, and test if the network is in good condition. 2. Make sure the settings on your device are correct.
System freezes suddenly.	<ol style="list-style-type: none"> 1. The radio is overloaded, reboot the unit.

Technical Specifications

WiFi Internet Radio SIR 5000WDB

Easy Operation with Unique Control Button
More than 26 000 Internet Radio Stations
AirMusic Control App (iOS/Android)

Internet Radio:

Easy Connection via Wifi
Local Station Search by Auto/Country/City
Favorite Station List
Station Presets: 250 (Internet)
Manage Radio Station via MediaU Website

Sound:

Power Output: 6 W (Impedance: 4 Ω)
Frequency Response: 84 Hz–16 kHz
Total Harmonic Distortion: L/R $\leq 5\%$ (1KHz)
8 Equalizer Modes

Display:

2.4" Full Color LCD Display
Dimmer

Reception:

DAB+ Tuner (Digital Audio Broadcasting)
FM PLL Radio Tuner
Radio Data System (RDS)
Station Presets: 20 (FM)

Inputs:

Bluetooth - Wireless Audio Streaming
Line In (3.5mm Stereo Jack)

Others:

Weather Forecast for 5000 cities
Support UPnP/DLNA
Time, Alarm, Sleeper
Headphones Output (3.5mm Stereo Jack)
Accessories: IR Remote Controller, Battery, Adaptor,
3.5mm Aux Jack, Manual
Power Supply: Adaptor 9 V, 1.5 A
Consumption: Max. 16 W
Energy Efficiency: <3 W
Dimension (Main Unit): 220 x 110 x 110 mm
Weight: 1.1 kg

For full user's instructions version, please refer to www.sencor.eu.

INSTRUCTIONS AND INFORMATION REGARDING THE DISPOSAL OF USED PACKAGING MATERIALS

Dispose of packaging material at a public waste disposal site.

DISPOSAL OF USED ELECTRICAL AND ELECTRONIC APPLIANCES



The meaning of the symbol on the product, its accessory or packaging indicates that this product shall not be treated as household waste. Please, dispose of this product at your applicable collection point for the recycling of electrical & electronic equipment waste. Alternatively in some states of the European Union or other European states you may return your products to your local retailer when buying an equivalent new product. The correct disposal of this product will help save valuable natural resources and help in preventing the potential negative impact on the environment and human health, which could be caused as a result of improper liquidation of waste. Please ask your local authorities or the nearest waste collection centre for further details. The improper disposal of this type of waste may fall subject to national regulations for fines.

For business entities in the European Union

If you wish to dispose of an electrical or electronic device, request the necessary information from your seller or supplier.

Disposal in other countries outside the European Union

If you wish to dispose of this product, request the necessary information about the correct disposal method from local government departments or from your seller.



The product meets EU requirements.

Hereby, FAST ČR, a.s. declares that the radio equipment type SIR 5000WDB is in compliance with Directive 2014/53/EU.

The full text of the EU declaration of conformity is available at the following internet address: www.sencor.eu.

Changes in the text, design and technical specifications may be made without prior notice and we reserve the right to make such changes.

The original version is in the Czech language.

Address of the manufacturer:

FAST ČR, a.s., Černokostecká 1621, Říčany CZ-251 01

SENCOR®

EN Warranty conditions

Warranty card is not a part of the device packaging.

This product is warranted for the period of 24 months from the date of purchase to the end-user. Warranty is limited to the following conditions. Warranty is referred only to the customer goods using for common domestic use. The claim for service can be applied either at dealer's shop where the product was bought, or at below mentioned authorized service shops. The end-user is obligated to set up a claim immediately when the defects appeared but only till the end of warranty period. The end user is obligated to cooperate to certify the claiming defects. Only completed and clean (according to hygienic standards) product will be accepted. In case of eligible warranty claim the warranty period will be prolonged by the period from the date of claim application till the date of taking over the product by end-user, or the date the end-user is obligated to take it over. To obtain the service under this warranty, end-user is obligated to certify his claim with duly completed following documents: receipt, certificate of warranty, certificate of installation.

This warranty is void especially if apply as follows:

- Defects which were put on sale.
- Wear-out or damage caused by common use.
- The product was damaged by unprofessional or wrong installation, used in contrary to the applicable instruction manual, used in contrary to legal enactment and common process of use or used for another purpose which has been designed for.
- The product was damaged by uncared-for or insufficient maintenance.
- The product was damaged by dirt, accident of force majeure (natural disaster, fire, and flood).
- Defects on functionality caused by low duality of signal, electromagnetic field interference etc.
- The product was mechanically damaged (e.g. broken button, fall).
- Damage caused by use of unsuitable media, fillings, expendable supplies (batteries) or by unsuitable working conditions (e.g. high temperatures, high humidity, quakes).
- Repair, modification or other failure action to the product by unauthorized person.
- End-user did not prove enough his right to claim (time and place of purchase).
- Data on presented documents differs from data on products.
- Cases when the claiming product cannot be indentified according to the presented documents (e.g. the serial number or the warranty seal has been damaged).

Authorized service centers

Visit www.sencor.eu for detailed information about authorized service centers.

SENCOR®

Let's live!



Designed in Europe by Sencor®, Made in China

www.sencor.cz

