

XENON FLASHING BEACONS FEUX A ECLATS

FLASH E



FLASH E

| | | | | | |
|------------------------------|---|-------|------------|------|------------|
| V 12-24 | ⎓ | IP 55 | °C -30 +40 | On ∞ | PC |
| | | | Flash/min. | | A |
| ECE R65 TB1 (E3) 00 7026 | | | ≥120 | 10J | V12: 3 A |
| ECE R65 TA1 (E3) 00 7027 | | | ≥120 | 10J | V24: 1,5 A |
| EMC 2006/28/CE [e24] 03 1483 | | | | BV | |



FLASH E FLX

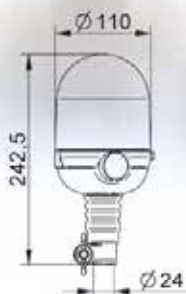

Kg. 0,64



FLASH E B

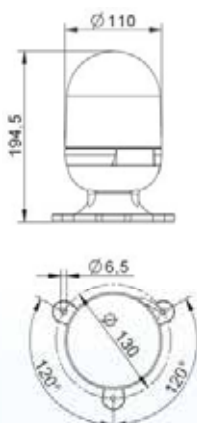

Kg. 0,54



FLASH E A

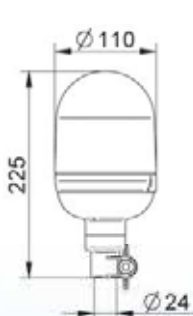

Kg. 0,61



FLASH E P

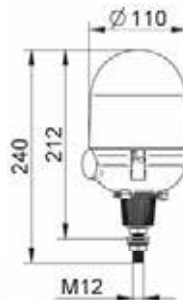

Kg. 0,58



FLASH E M

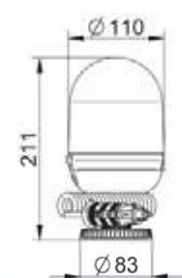

Kg. 0,95



FLASH E MV

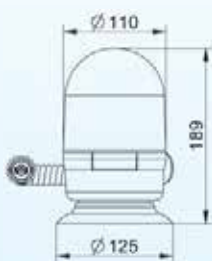

Kg. 1,10



FLASH E 3MV

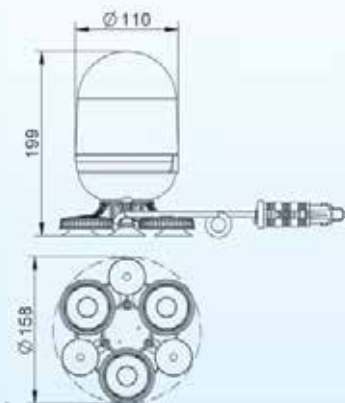

Kg. 1,07

- Xenon flashing beacon with unbreakable polycarbonate dome and flexible rubber base, vibration-proof (standard ISO A mount)
- Rigid versions with polyamide reinforced fibreglass base with PVC coating also available
- Xenon discharge tube 10J (single flash)

- Feu à éclats avec dôme incassable en polycarbonate et base flexible en caoutchouc antivibrations (fixation standard ISO A)
- Versions non-flexibles avec base en polyamide renforcé fibre de verre et revêtement en PVC disponibles sur demande
- Tube à décharge au xénon 10J (simple éclat)

| part no. code | type type | voltage tension | colour couleur |
|---------------|--------------------|-----------------|----------------|
| 73954 | FLASH E FLX 1F 10J | V12/24D | 7 |
| 73951 | FLASH E B 1F 10J | V12/24D | 7 |
| 73952 | FLASH E A 1F 10J | V12/24D | 7 |
| 73953 | FLASH E P 1F 10J | V12/24D | 7 |
| 73955 | FLASH E M 1F 10J | V12/24D | 7 |
| 73956 | FLASH E MV 1F 10J | V12/24D | 7 |
| 73957 | FLASH E 3MV 1F 10J | V12/24D | 7 |