



**MOTOROLA**

# Professional Radio

## GP344

User Guide

68P64110B98

Issue: Nov 2001

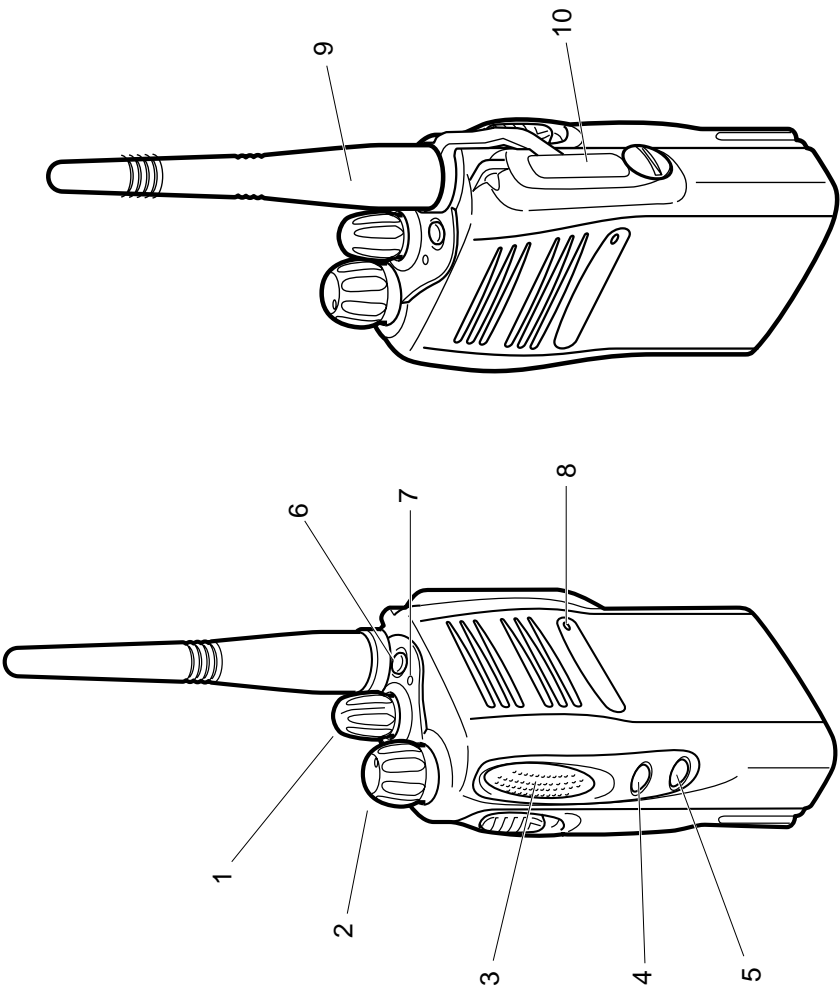

## CONTENTS

<b>Radio Overview</b> .....	<b>3</b>	Selecting a Radio Channel .....	11
Operation and Control Functions .....	3	Sending a Call .....	12
Radio Controls .....	3	Receiving a Call .....	12
Programmable Buttons .....	3	<b>Radio Calls</b> .....	<b>13</b>
Audio Signal Tones .....	6	Selective Call .....	13
<b>Getting Started</b> .....	<b>7</b>	Making a Selective Call .....	13
Battery Information .....	7	Receiving a Selective Call .....	13
Battery Care and Tips .....	7	Emergency Call .....	14
Recycling or Disposal of Batteries .....	8	Lone Worker .....	15
Charging the Battery .....	8	Talkaround .....	16
<b>Accessory Information</b> .....	<b>9</b>	<b>Features</b> .....	<b>17</b>
Attaching the Battery .....	9	Transmit Power .....	17
Removing the Battery .....	9	Whisper .....	18
Attaching the Antenna .....	10	Call Forward .....	19
Removing the Antenna .....	10	Voice Operated Transmit (VOX) .....	20
<b>Radio Operation</b> .....	<b>11</b>	<b>Scan</b> .....	<b>21</b>
Turning the Radio On-Off .....	11	Starting or Stopping Scan .....	21
Adjusting the Radio's Volume .....	11	Talkback .....	21
		Deleting a Nuisance Channel .....	22
		Adding a Deleted Nuisance Channel .....	22

<b>Safety Information .....</b>	<b>23</b>
<b>Notes .....</b>	<b>24</b>

## Computer Software Copyright

The products described in this manual may include copyrighted computer programmes stored in semiconductor memories or other media. Laws in the United States of America and other countries preserve for Motorola Europe and Motorola Inc. certain exclusive rights for copyrighted computer programmes, including the right to copy or reproduce in any form the copyrighted computer programme. Accordingly, any copyrighted computer programmes contained in the products described in this manual may not be copied or reproduced in any manner without the express written permission of the holders of the rights. Furthermore, the purchase of these products shall not be deemed to grant either directly or by implication, estoppel, or otherwise, any licence under the copyrights, patents, or patent applications of the holders of the rights, except for the normal non-exclusive royalty free licence to use that arises by operation of the law in the sale of the product.

## RADIO OVERVIEW

This user guide covers the operation of the GP344 Portable Radio.

**Before** using this radio, refer to Important Safety and General Information contained in the separate booklet 68P64117B25\_ enclosed with your radio.

### OPERATION AND CONTROL FUNCTIONS

#### Radio Controls

The numbers below refer to the illustrations on the inside front cover.

1. **Channel Selector Knob**  
Allow selection of up to 16 channels.
2. **On-Off / Volume Knob**  
Used to turn the radio on or off, and to adjust the radio's volume.
3. **Push to Talk Button (PTT)**  
Press and hold down this button to talk, release it to listen.
4. **Side Button 1 (programmable)**
5. **Side Button 2 (programmable)**
6. **Top Button (programmable)**  
Recommended for Emergency Button.
7. **LED Indicator**  
**Green:** Successful power up.  
**Green Flashing:** Radio scanning.  
**Red:** Radio transmitting.  
**Red Flashing:** Channel busy - when receiving.  
**Yellow:** Radio called.  
**Yellow Flashing:** Radio call reminder alert.  
**Red Flashing:** Low battery warning - when transmitting.
8. **Microphone**  
Speak clearly into the microphone when sending a message.
9. **Antenna**
10. **Accessory Connector**  
Connects headsets, remote speaker/microphones and other accessories. Replace attached dust cap when not in use.

#### Programmable Buttons











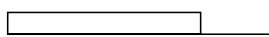
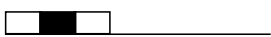



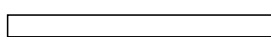





Several of your radio buttons can be programmed, by the Customer Programming Software (CPS), to activate the radio features. The following table shows the features that can be assigned to the Top button and the two Side Buttons.

<b>Feature</b>	<b>Description</b>
Monitor/Cancel	To monitor the selected channel for any activity or to cancel a current outgoing or incoming call.
Radio Call	To make an individual or group selective call.
Scan On/Off	To toggle between start and stop of the scan operation.
Nuisance Delete	To delete a nuisance channel while scanning.
Transmit Power	To toggle your radio's transmit power level between High and Low power.
Talkaround On/Off	To talk directly with another radio without going through a system or dispatcher.
Emergency	To activate the Emergency alarm call.
Lone Worker	To identify yourself as a lone worker. Radio enters emergency sequence unless you respond when prompted by pressing any radio button.

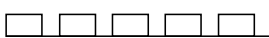
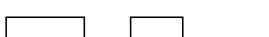
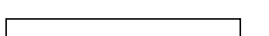
Feature	Description
Call Forward	To transfer calls automatically to another radio if you are unable to take the call.
Whisper	To increase the microphone gain to allow you to speak quietly.

## Audio Signal Tones

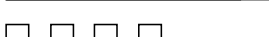
High pitched tone  Low pitched tone

	Power Up - Radio self-test OK		Priority Call detected
	Power Up - Radio self-test Fail		H/W error - tone continues until valid operation.
	Button Error		Lone Worker Reminder
	Force Monitor(PTT pressed)		Low Battery
	Feature Enable Side Buttons/ Top Button		Incoming Ringing Tone
	Feature Disable Side Buttons/ Top Button		Outgoing Ringing Tone
	Channel Busy Tone/ Engaged		Channel Free Beep
	Channel Busy Tone/ Engaged		Incoming Emergency Alert
	Individual Call Alert		
	Call Reminder		
	Group Call Alert		
	TOT Pre Alert		
	Monitor Alert		
	Call Failed		
	Scan Start		
	Scan Stop		
	Priority Channel		



## GETTING STARTED

### BATTERY INFORMATION

#### Battery Care and Tips

This product is powered by a lithium-ion rechargeable battery.

The following battery tips will help you obtain the highest performance and longest cycle life from your Motorola rechargeable battery.

- Charge your new battery overnight (**14-16 hrs**) before using it to obtain maximum battery capacity and performance.
- Charging in non-Motorola equipment may lead to battery damage and void the battery warranty.
- When charging a battery that is attached to the radio, turn the radio off to ensure a full charge.
- The battery should be at about 25°C (room temperature) whenever possible. Charging a cold battery (below 10°C) may result in leakage of electrolyte and ultimately, in failure of the battery.
- Charging a hot battery (above 35°C) results in reduced discharge capacity, affecting the performance of the radio. Motorola rapid-rate battery chargers contain a temperature-sensing circuit to ensure that the battery is charged within these temperature limits.
- New batteries can be stored up to two years without significant cycle loss. Store new/unused batteries, at room temperature, in cool dry area.
- Batteries which have been in storage should be charged overnight.
- Do not return fully charged batteries to the charger for an “extra boost”. This action will **significantly** reduce cycle life.
- Do not leave your radio and battery in the charger when not charging. Continuous charging will shorten battery life. (Do not use your charger as a radio stand.)
- For optimum battery life and operation use only Motorola brand chargers. They were designed to operate as an integrated energy system.

### Recycling or Disposal of Batteries

Motorola endorses and encourages the recycling of all re-chargeable batteries. Contact your local Motorola dealer for further information.

### Charging the Battery

If a battery is new, or its charge level is very low, you will need to charge the battery before you can use it in your radio.

Please contact your dealer for further information.

**Note:** Batteries are shipped uncharged from the factory. New batteries could prematurely indicate full charge, charge a new battery for 14-16 hrs before initial use.

Charger LED	Status
Red	Battery is charging
Green	Battery is fully charged
Flashing Red *	Battery is unchargeable
Flashing Yellow	Charger is getting ready to charge
Flashing Green	Battery is 90% charged

\* Battery is damaged. Please contact your dealer.

1. Place the radio with the battery attached, or the battery alone, in the charger.
2. The charger's LED indicates the charging progress.

Battery chargers will charge only the Motorola authorized batteries listed below; other batteries will not charge.

Part No.	Description
JMNN4023	Lithium-Ion
JMNN4024	Lithium-Ion - High Capacity

## ACCESSORY INFORMATION

### Attaching the Battery

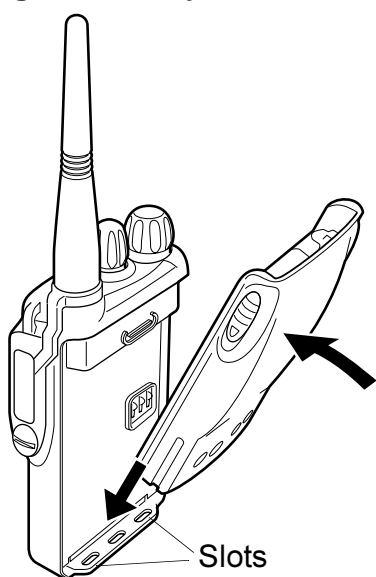

1. Fit the extensions at the bottom of the battery into the slots at the bottom of the radio's body.
2. Press the top part of the battery towards the radio until you hear a click.

### Removing the Battery

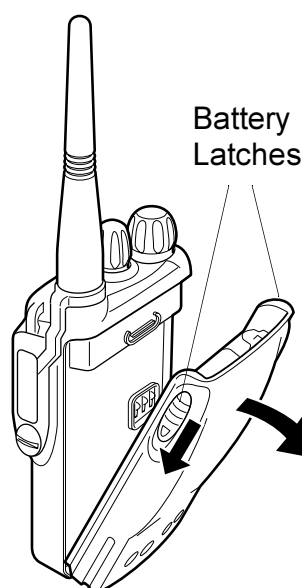

1. Turn off the radio, if it is turned on.
2. Slide the battery latches, on both sides of the battery, downwards.
3. Pull the top part of the battery away from the radio's body, and remove the battery.

### Attaching the Antenna

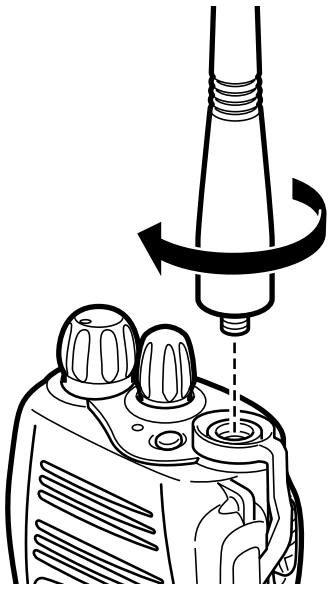

1. Align the threaded end of the antenna with the radio's antenna connector.
2. Turn the antenna clockwise to fasten it.

### Removing the Antenna

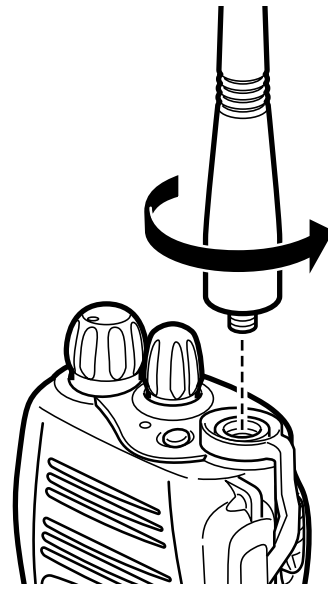

1. Turn the antenna counterclockwise until you can remove it.

## TURNING THE RADIO ON OR OFF

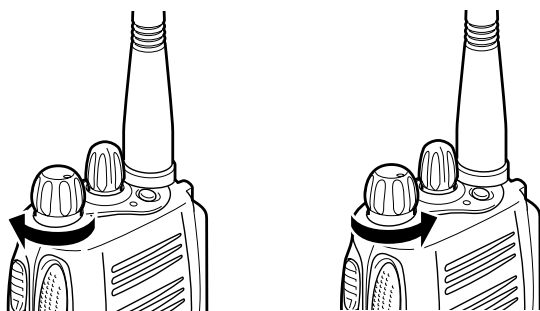

ON

OFF

- To turn the radio on, turn the **On-Off/Volume Control** knob clockwise.
- To turn the radio off, turn the **On-Off/Volume Control** knob counterclockwise until you hear a click.

## ADJUSTING THE RADIO'S VOLUME

- Turn the **On-Off/Volume Control** knob to adjust the volume level.

## SELECTING A RADIO CHANNEL

Your radio offers 16 channels, however some may not be programmed. Check with your dealer for more information.

- Turn the **Channel Selector** knob clockwise or counterclockwise until you reach the desired channel indicated on the selector graduation.

**SENDING A CALL**

1. Use the **Channel Selector** knob to change to the required channel.
2. Press the **PTT** button and speak clearly into the microphone. Your mouth should be about 2.5 - 5cm away from the microphone.
3. Release the **PTT** button when you finish speaking.

**RECEIVING A CALL**

1. Turn your radio on and adjust the volume level.
2. Switch to the desired channel.
3. If, at any time, a call is received, you will hear the call at the volume level you have set.

## RADIO CALLS

### SELECTIVE CALL

#### Making a Selective Call

You can make a selective call to a particular radio, known as an individual call, or to a selected group of radios, known as a group call.

To make a Selective Call :

1. Press the PTT or Call Button (depending on the way your radio has been programmed by your dealer), to set up the call.
2. Wait until the conversation has been set up, which means you are authorised to use the system.
3. Talk with your mouth 2.5 - 5cm from the microphone. Release PTT to listen.
4. When transmitting the red indicator will light continuously.







Your radio may be configured for 'Transmit Inhibit' under certain conditions (e.g. when the channel is in use by others) in which case, the channel busy tone will sound when you press

the PTT or call button to indicate that transmission is inhibited.

When the channel is free, the Channel Free beep  will sound, and you can make a call.

If your radio is equipped with a transmit time out timer (TOT), a warning tone  will sound a few seconds before the transmission is cut off. Your radio may be programmed to inhibit retransmission within a preset time.

#### Receiving a Selective Call

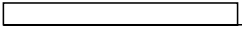
When you receive a selective call, you will hear either an individual call alert tone      , or a group call alert tone  and the LED Indicator will light (yellow).

To answer the call:

1. Press the PTT button or Call button.
2. The call will terminate automatically when the conversation has ended or press the Monitor button.

## EMERGENCY CALL

Your radio can be programmed to give you a one-button quick access to call a particular radio or centre (predefined by your dealer) in emergency situations. This is the *Emergency Call*.

When you make an Emergency call, your radio goes into an Emergency state, which can be programmed to:

- continually give audio feedback,
  - give no audio feedback; the radio can receive and transmit.
1. Press the **Emergency** button to initiate an Emergency call.
  2. Emergency can be stopped by:
    - Switching the radio **Off** and **On** again.
    - A **reset** message is received by your radio.
    - The emergency time duration is reached.

**Note:** The emergency time duration and reset message are programmed into your radio by your dealer.

Should you receive an Emergency call the incoming emergency alert tone   will sound.



## LONE WORKER

The Lone Worker feature enables you to work alone with added safety. To use this feature:

1. Press the **Lone Worker** button.
2. The feature enable alert \_\_\_\_\_ will sound.

You will be reminded at intervals that **Lone Worker** is switched **on** by a high pitched alert  being sounded.

- Press **any button** to respond and cancel the alert, if you do **not** the radio will enter the Emergency state.

To switch off this feature:

1. Press the **Lone Worker** button when the feature disable alert \_\_\_\_\_ will sound  
or,
2. Change the channel  
or,
3. Switch radio **off** and **on** again.

## TALKAROUND

In your communications network, you may be using a system to cover a larger area than is possible with your radio. However, you can communicate with another radio within your radio's range without going through the system by using the *Talkaround* feature. This is especially useful when the system is down. To use this feature:

1. Press the **Talkaround** button to switch **on** talkaround when the feature enable alert  \_\_\_\_\_ will sound.
2. Press the **Talkaround** button again to switch **off** talkaround when the feature disable alert  \_\_\_\_\_ will sound.

## FEATURES

The features described below are programmed into your radio by your dealer and are accessible via the radio's programmable buttons.

### TRANSMIT POWER

You can transmit your calls at different transmit power levels. A higher level means you can reach a radio that is farther away. A lower power level conserves battery power. You are advised to transmit as frequently as possible on low power, and use high power only when needed. To use this feature:

1. Press the **Tx Power** button to switch to **high power** when the feature enable alert  \_\_\_\_\_ will sound.
2. Press the **Tx Power** button again to switch to **low power** when the feature disable alert  \_\_\_\_\_ will sound.

## WHISPER

Whisper allows you to talk quietly into the radio microphone when making a call.

To switch Whisper on:

1. Press the Whisper button once, when the feature enable alert \_\_\_\_\_ will sound.

To switch Whisper off:

1. Press the Whisper button again, when the feature disable alert \_\_\_\_\_ will sound.

## CALL FORWARD

You can call forward calls to your radio to another radio if you are unable to take calls or are away from your radio.

To enable Call Forward:

1. Press the Call Forward button once, when the feature enable alert \_\_\_\_\_ will sound.

To disable Call Forward:

1. Press the Call Forward button again, when the feature disable alert \_\_\_\_\_ will sound.

## VOICE OPERATED TRANSMIT (VOX)

When the VOX headset/microphone is connected, your radio may be used with hands-free operation.

To start the VOX feature:

1. Connect the VOX headset onto the accessory connector of the radio.
2. Switch On the radio.

You can disable the VOX feature by pressing the PTT button on the radio. This allows you to use the VOX headset but you must press the radio PTT to transmit.

To re-enable the VOX feature:

1. Switch the OFF and ON again with the headset connected to the accessory connector  
or,
2. Change channel with the VOX headset connected.



## SCAN

You can monitor several channels in order to receive any call that is transmitted on any of these channels. Sixteen different channels can be programmed into each scan list. Each channel can share the same scan list or have different scan lists assigned to them.

Once the radio's scan operation is activated and the radio detects a call coming through a channel in its scan list, it switches to that channel for you to receive the call.

### STARTING OR STOPPING SCAN

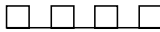
You can start or stop a scan operation by using the **Scan** button.

1. Press the **Scan** button to start scanning. The scan start alert tone  will sound.
2. Press the **Scan** button again to stop scanning. The scan stop alert tone  will sound.

The LED indicator will blink green during a scan operation; it will stop blinking when the radio switches to a channel.

### TALKBACK

If the programmable Talkback option is set, you can respond to any calls received during the scan operation by pressing the PTT button before the programmed hang-time ends. Check with your dealer for details.

## DELETING A NUISANCE CHANNEL

If a channel continually generates unwanted calls/noise (a “nuisance” channel), you can temporarily remove it from the scan list by performing a *Nuisance Channel Delete* operation:

1. While the radio is on the Nuisance Channel, press and hold the **Nuisance Delete/Cancel** button until you hear the scan start alert tone     \_\_\_\_\_.
2. Release the **Nuisance Delete/Cancel** button.

**Note:** You cannot perform a Nuisance Channel Delete on a priority channel or if there is only one remaining channel in the scan list.

## ADDING A DELETED NUISANCE CHANNEL BACK INTO THE SCAN LIST

1. Press the **Scan** button to stop scanning. The scan stop alert tone     \_\_\_\_\_ will sound.
2. Press the **Scan** button again to re-start scanning. The scan start alert tone     \_\_\_\_\_ will sound, and the scan list will contain all programmed channels.



## SAFETY INFORMATION

**Before** using this radio, refer to Important Safety and General Information contained in the separate booklet 68P64117B25\_ enclosed with your radio.

## NOTES