



INSTRUCTION MANUAL

MARINE RADAR

MR-570R

Icom Inc.

SYSTEM COMPONENTS

MODEL NAME	DISPLAY UNIT	SCANNER UNIT
SX-2464	EX-2473 (5.7 inch LCD)	EX-2474 (Radome type)

SUPPLIED ACCESSORIES

•EX-2473 (5.7 inch LCD display unit)

	Qty.
① NMEA connector (NS1007 7P).....	2
② Spare fuse (FGB 10 A)	1
③ Spare fuse (FGB 5 A: for over 24 V power supply)	1
④ DC power cable (OPC-928).....	1
⑤ NMEA connector cover.....	2
⑥ Self-tapping screws (5 x 30)	4
⑦ Spring washers (M5)	4
⑧ Flat washers (M5)	4
⑨ Mounting spacer	4
⑩ Mounting rubbers	4

•EX-2474 (Scanner unit)

	Qty.
① System cable (OPC-1075: 10 m).....	1
② Installation bolts (M10 x 50)	4
③ Installation bolts (M10 x 25)	4
④ Installation nuts (M10)	4
⑤ Flat washers (M10)	4
⑥ Spring washers (M10)	4

IMPORTANT

READ ALL INSTRUCTIONS carefully and completely before attempting to operate the marine radar.

SAVE THIS INSTRUCTION MANUAL. This manual contains important safety and operating instructions for the MR-570R.

PRECAUTIONS

⚠ **NEVER** let metal, wire or other objects touch any internal part of the radar.

⚠ **NEVER** place the radar within the reach of children.

⚠ **NEVER** expose the display unit to rain, salt water or any other liquids.

NEVER connect the radar to AC or more than 42 V DC. This will damage the radar.

AVOID placing the display unit in excessively dusty environments or in direct sunlight.

AVOID placing the display unit near heating equipment or in direct sunlight or where hot or cold air blows directly onto it.

AVOID using the scanner unit in areas where the temperature is below -25°C (-13°F) or above $+70^{\circ}\text{C}$ ($+158^{\circ}\text{F}$). **AVOID** using the display unit in areas where the temperature is below -15°C ($+5^{\circ}\text{F}$) or above $+55^{\circ}\text{C}$ ($+131^{\circ}\text{F}$).

AVOID using strong solvents such as benzene or alcohol for cleaning the radar, as they may damage the surfaces.

FOREWORD

Thank you for purchasing ICOM's **MR-570R MARINE RADAR**.

The radar is designed especially for fishing boats. It has powerful transmission power, a 5.7 inch LCD display and many other advanced features.

If you have any questions regarding the operation of the radar, contact your nearest authorized Icom Inc. dealer.

EXPLICIT DEFINITIONS

The following explicit definitions apply to this instruction manual.

WORD	DEFINITION
⚠ WARNING	Personal injury, fire hazard or electrical shock may occur.
⚠ CAUTION	Equipment damage may occur.
NOTE	If disregarded, inconvenience only. personal injury, fire hazard or electrical shock will not occur.

CAUTION!

SART signal may not be detected and may not be displayed on the screen depending on the **SEA**, **RAIN** or **IR** settings.

Follow the following settings to detect the **SART** signal on the screen.

1. Select the screen range between 6 NM to 12 NM.
2. Set the [GAIN]* as high as possible.
3. Set the [SEA]* to minimum.
4. Set the [RAIN]* to minimum.
5. Turn the [IR]* OFF.
6. Turn the [ES]* OFF.

*See the [ADJ] menu on p. 6.

TABLE OF CONTENTS

SYSTEM COMPONENTS.....	i	■ Minimum range	24
SUPPLIED ACCESSORIES.....	i	■ Blind and Shadow sectors	25
IMPORTANT	ii	■ Target resolution.....	25
PRECAUTIONS	ii	9 INSTALLATION AND CONNECTIONS	26–30
FOREWORD	ii	■ Connecting the units	26
EXPLICIT DEFINITIONS	ii	■ Power source requirement	26
TABLE OF CONTENTS	iii	■ Ground connection	26
		■ Installing the EX-2473 display unit	27
		■ Mounting the EX-2474 scanner unit	28
		■ Wiring the system cable	29
1 CAUTION	1	10 SERVICE MAN MENU	31–34
DANGER! HIGH VOLTAGE	1	■ Service man menu	31
RADIATION HAZARD	1	■ Select the language	31
2 PANEL DESCRIPTION	2–5	■ SPD adjustment	32
■ Front panel	2	■ HDG adjustment.....	32
■ Screen	4	■ TIMING adjustment	33
3 MENU	6–9	■ MBS adjustment	33
■ BRILL MENU	6	■ RANGE selection	34
■ ADJ (Adjust menu)	6	■ Tuning adjustment.....	34
■ FUNCTION MENU	7	■ Auto gain adjustment.....	34
■ EPA.....	8	11 ERROR MESSAGE	35
■ INT. SETTING	9	■ Error message list	35
4 BASIC OPERATION	10–13	12 MAINTENANCE	36
■ Checking the installation	10	■ Periodic maintenance	36
■ Turning power ON/OFF	10	■ Scanner unit maintenance	36
■ Basic operation	11	■ Display unit maintenance	36
■ RAIN function	12	■ Options	36
■ SEA function.....	12	13 SPECIFICATIONS	37
■ OFF CENTER function.....	12	14 EXTERNAL DATA LIST	38
■ IR function	13	15 TEMPLATE	39–41
■ ECHO STRETCH function	13	■ Template for the display unit	
■ ZOOM function	13	• EX-2473 (LCD Display).....	39
■ TRAILS function	14	■ Template for the scanner unit	
■ Power save function	14	• EX-2474 (RADOME)	41
■ Ship speed indication	15	16 ABOUT CE	43
■ Position indication	15		
■ Way point indication	15		
■ Long pulse function	15		
■ Bearing setting	15		
5 DISTANCE AND DIRECTION			
MEASUREMENTS	16–18		
■ Distance measurement	16		
■ Bearing and Distance measurement	17		
■ Advanced measurement	18		
6 ALARM FUNCTION	17		
■ Alarm zone setting	19		
■ Zone alarm setting	19		
7 EPA (Electronic Plotting Aid)	20–22		
■ EPA (Electronic Plotting Aid)	20		
■ EPA menu setting	20		
■ EPA operation	21		
■ Correct the target	21		
■ Clear the target	22		
■ Plotting marks	22		
■ Course and speed vector	22		
■ Plots	22		
8 BASIC RADAR THEORY	23–25		
■ Side-lobe echoes	23		
■ Indirect echoes	23		
■ Multiple echoes	24		

The MR-570R is supplemental aids to navigation and are not intended to be a substitute for accurate and current nautical charts.

DANGER! HIGH VOLTAGE

• NEVER OPEN THE UNIT

This product contains high voltage that could be FATAL. This product has no user-servicable parts inside. All repairs and adjustments MUST be made by a qualified electronics technician at your Marine Navigation Dealer.

• HIGH VOLTAGE

High voltages of up to 3,500 volts are used in this equipment. Although prudent measures for safety have been adopted, sufficient care must be taken in the operation, maintenance and adjustment of the equipment.

Electric shock of 1,000 volts or more may cause electrocution and death; even an electric shock of only 100 volts may be fatal.

**• PREVENTION OF ELECTRIC SHOCK
(FOR QUALIFIED ELECTRONIC TECHNICIANS ONLY)**

To prevent such accidents, turn OFF the power source and do not reach inside the unit until you have:

- ① Discharged the capacitors by disconnecting the power cable from the power source for 5 min.;
- ② Checked that no electric charges remain inside the device.

Also, it is safest to wear dry insulated rubber gloves. **NEVER** use both hands simultaneously; keep one hand in your pocket.

RADIATION HAZARD

- Radiation emitted from the scanner unit can be harmful, particularly to the eyes. To avoid harmful radiation, ensure the radar power is in the OFF position before beginning work on the scanner unit.

■ Front panel

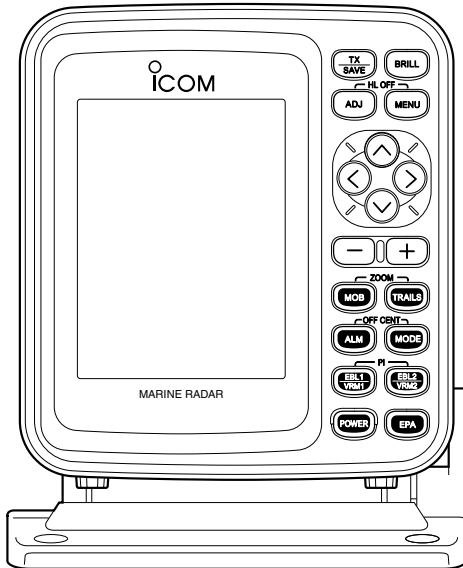

Control panel

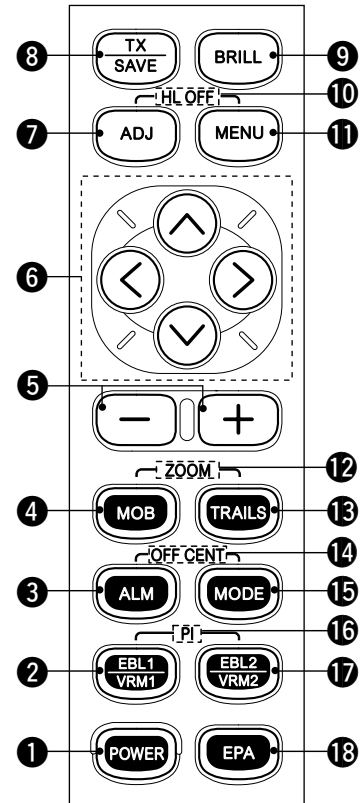

1 POWER SWITCH [POWER] (p. 10)

Turns power ON and OFF.

- The standby screen appears for 90 sec. while warming up the magnetron.
- The initial screen appears with a beep after the power has been turned ON.

2 EBL1 (VRM1) SWITCH [EBL1 (VRM1)] (pgs. 16–18)

Push to display the electronic bearing line 1 (EBL1) and the variable range marker 1 (VRM1) on the cross line cursor position from own ship.

- EBL1 bearing and VRM1 distance are displayed, in the bottom window.
- When EBL1 and VRM1 are displayed, the beginning of EBL2 appears at own ship or the intersection point of EBL1 and VRM1.

3 ALARM SWITCH [ALM] (p. 19)

Push [ALM] to toggle the alarm function ON and OFF.

Push and hold [ALM] for 0.5 sec. to enter the alarm area setting condition.

- Push [^]/[v]/[<]/[>] key to move the cross cursor to the zone starting point, then push [ALM] for 0.5 sec. The starting ring of the zone is created. Then push [^]/[v]/[<]/[>] to fix the finish point, the desired alarm zone will automatically form.

4 MAN OVERBOARD [MOB]

Push to mark the man overboard point on the screen. In the case of when a crew member falls overboard, push [MOB] to display the MOB marker (☑) on the screen.

- MOB readout shows the bearing, distance and estimated time to the MOB point with current speed.
- Push and hold [MOB] for 0.5 sec. to cancel the function.
- Position and bearing data are necessary.
- External data is required for screen display information. (p.38).

5 RANGE UP/ DOWN SWITCH [+/-] (p. 16)

Push [+] to increase the screen range.

Push [-] to decrease the screen range.

6 UP, DOWN, LEFT, RIGHT KEY [UP][DOWN][RIGHT][LEFT]

Set the cross line cursor, alarm area, EPA target, etc. according to the switch pushed.

Use the [^]/[v] key to select menu item and [<]/[>] key to set the item.

Using the [^]-[<]/[>] or [v]-[<]/[>] key combination allows you to move the cross line cursor to the upper (or lower) left or right.

7 ADJUST MENU [ADJ] (p. 6)

Push [ADJ] to show the adjust menu on the display.

- Adjustable items; TUNE, GAIN, SEA, RAIN, IR, ES, PULSE length.

8 TRANSMIT/SAVE SWITCH [TX (SAVE)] (p. 11)

Push to toggle between the TX mode and the standby mode.

Push and hold for 0.5 sec. to turn the power save function ON. The radar for TX interval scan is fixed at 10 revolutions. (p. 14)

- Select the save time in FUNCTION menu.

9 DISPLAY BRILLIANCE SWITCH [BRILL] (p. 6)

Push [BRILL] to turn the brilliance adjustment menu ON or OFF.

• The brilliance and contrast of the symbol, character and illumination can be adjusted in [BRILL.] and [CONTR.] of the [BRILL] menu independently.

• Positive or Negative selection is available in [DISP.] menu.

• Pushing and holding [BRILL] for 1 sec. to turn the contrast and brilliance to the default setting.

10 HEADING LINE OFF FUNCTION [HL OFF] (p. 11)

Push [ADJ] and [MENU] simultaneously to turn off all indication except the PPI (Plan Position Indicator) screen, temporarily.

11 MENU SWITCH [MENU] (pgs. 7–9)

Push [MENU] to toggle the FUNCTION and EPA menu. Push [^]/[v] keys to select the items and push [<]/[>] keys to change the setting.

- Enter the “INT. SETTING” from the “EPA” menu.
- Enter the “SERVICE MAN” menu from the “INT SETTING MENU”.

12 ZOOM FUNCTION [ZOOM] (p. 13)

Push [MOB] and [TRAILS] simultaneously to toggle the ZOOM function ON and OFF. ZOOM function expands the target to 2 times normal.

• Move the cursor to the target, then turn the function ON.

• The screen zooms around the middle of the cursor and own ship.

• This function is not available at 1/8, 3/4 and 32 NM or above ranges.

13 TRAILS SWITCH [TRAILS] (p. 14)

Push to toggle the trail function ON and OFF. This is useful for watching other ship’s tracks, approx. relative speed etc.

- Trail Time can be set in FUNCTION menu.

14 OFF CENTER FUNCTION [OFF CENT] (p. 12)

Push [ALM] and [MODE] simultaneously to turn the OFF CENTER function ON or OFF.

- This function is not available at 32 NM or above ranges.

15 MODE SWITCH [MODE]

Push to select one of Head-up (H UP), Course-up (C UP), North-up (N UP) or True motion (TM) screens.

• The North-up, Course-up and TM screens require ‘External data’ (p. 38).

• TM screen is not available at 32 NM or above ranges.

16 PARALLEL INDEX LINE FUNCTION [PI]

Push [EBL1] and [EBL2] simultaneously to turn the parallel index line ON.

Push [EBL1] or [EBL2] to turn the line OFF.

• Push [<]/[>] keys to rotate the lines, and push [^]/[v] keys to adjust the line spaces.

17 EBL2 (VRM2) SWITCH [EBL2 (VRM2)] (pgs. 16–18)

Push to display the Electronic Bearing Line 2 (EBL2) and the Variable Range Marker 2 (VRM2) while EBL1 and VRM1 are displayed on the screen.

• Push [EBL2/VRM2] to toggle the center of VRM2 as follows.

Own ship → Intersection of the EBL1 and VRM1 → OFF.

18 EPA SWITCH [EPA] (pgs.20–22)

Push to enter the EPA position data.

Push the [EPA] for 0.5 sec. to toggle the EPA display and navigation display.

• Push [^]/[v]/[<]/[>] key to move the cross cursor on the echo which you want to plot on the screen before turning the function ON.

• Select “EPA” function ON in the “EPA” menu, set the appropriate VECT, No. DISP, ALARM, CPA LIMIT and TCPA LIMIT setting.

• External data is required for screen display information. (p.38).

2 PANEL DESCRIPTION

■ Screen

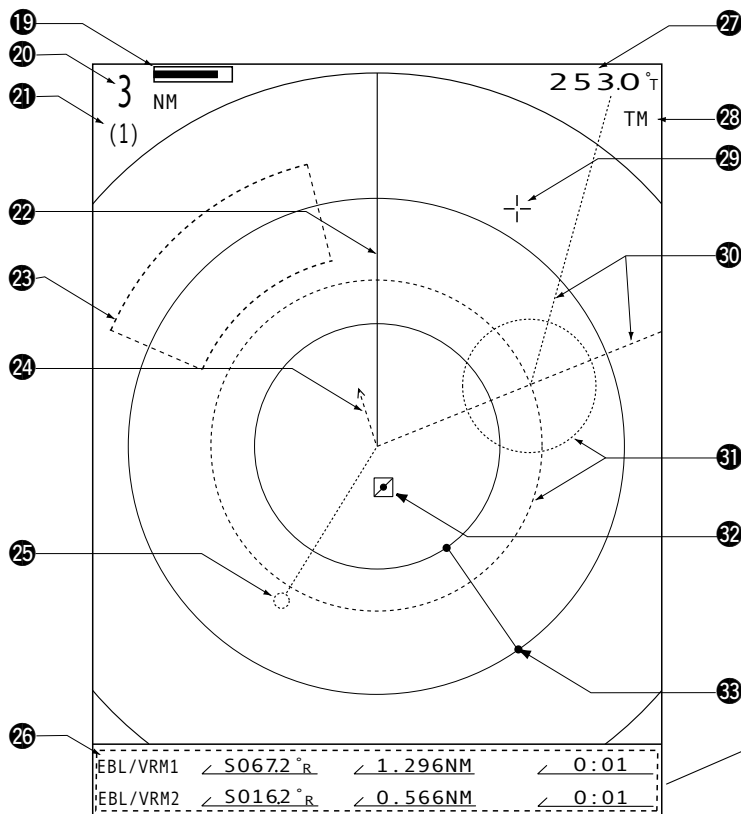

NOTE:
DATA display area may differ depending on DATA DISP selection in the FUNCTION menu.

19 TUNING LEVEL INDICATOR

Shows the receiver tuning level.

20 SCREEN RANGE READOUT (p. 16)

Shows the maximum range of the displayed screen.
• The range indicated ∠ is nautical miles (NM).

21 FIXED RING RANGE READOUT (p. 16)

Shows the interval range of the fixed ring.
• This readout appears when the "RING" of the FUNCTION menu is turned ON.

22 HEADING LINE (p. 11)

Heading line indicates the ship's bow.

23 ALARM ZONE (p. 19)

Shows the alarm zone.
• Appears when the alarm function is in use.
• External data is required for screen display information. (p.38).

24 OWN SHIP VECTOR INDICATOR

Shows the vector of your own ship.

25 WAYPOINT MARKER (p. 15)

Shows the waypoint received from navigation equipment.
• This marker appears when the "WPT" of the FUNCTION menu is turned ON.
• External data is required for screen display information. (p.38).

26 EBL1/VRM1,EBL2/VRM2 READOUTS (pgs. 16-18)

Shows the bearing of the displayed Electronic Bearing Lines (EBL) and the distance of the displayed Variable Range Markers (VRM).
• Nautical miles (NM) and kilometres (KM) can be selected in the INT.SETTING menu as the distance unit.

27 HEADING INDICATOR

Shows the heading bearing readout.
• The HDG readout indicates the bow of the ship's bearing in a clockwise direction from north.
• External data is required for screen display information. (p.38).

28 MODE INDICATOR

Head-up, Course-up (CUP), North-up (NUP) and True Motion (TM) screens are available.
• External data is required for screen display information. (p.38).

29 CROSS LINE CURSOR

Used for measuring the bearing and distance, setting the alarm zone, selecting the EPA targets, etc.
• Push [∧]/[∨]/[<]/[>] several times to move the cursor.

30 EBL1/2 (pgs. 16-18)

Used for bearing measurement. When a target is selected, the EBL readout **36** shows the bearing.

31 VRM1/2 (pgs. 16-18)

Used for distance measurement. When a target is selected, the VRM2 readout **23** shows the distance.

32 MOB SYMBOL

Push [MOB] to mark the [MOB] marker on the screen.

- External data is required for screen display information. (p.38).

33 FIXED RANGE RINGS (p. 16)

Shows the distance in fixed intervals.

- These rings appear when the “RING” of the FUNCTION is turned ON.

DATA DISPLAY

Data readout may differ depending on “DATA DISP” setting of the function menu.

When “OFF” is selected;



34 ALARM INDICATOR (p. 19)

Appears when the alarm function is in use.

35 TRAILS INDICATOR (p. 14)

Shows the trail time.

- Echo remains with gradation during the trail time period on the screen. (Except for the trail time; ∞)
- Progressing time counter starts to count the time until the timer reaches the trail time.

36 VECTOR INDICATOR (pgs. 20-22)

Shows the EPA and OWN vector type.

- Tv: True vector
- Rv: Relative vector
- External data is required for screen display information. (p.38).

37 SHIP SPEED READOUT (p. 15)

Shows the ship speed.

- SOG: When GPS is selected in the INT. SETTING menu.
- STW: When LOG is selected in the INT. SETTING menu.
- External data is required for screen display information. (p.38).

NOTE:

When L/L DISP function in the [FUNCTION] menu is turned ON, [CURS], [WPT] and [MOB] readouts will be displayed as Latitude/Longitude.
When L/L DISP function in the [FUNCTION] menu is turned OFF, [CURS], [WPT] and [MOB] readouts will be displayed as bearing and distance.

When “CURS” or “SHIP” is selected;

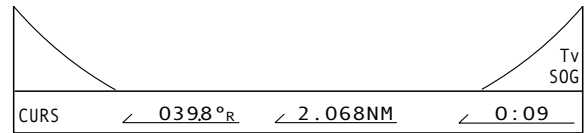

(CURS readout)

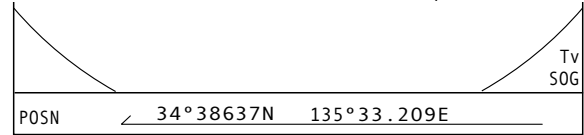

(SHIP readout)

38 POSITION/CURSOR READOUT (p. 15)

Shows your own ship or cursor latitude and longitude readout when external NMEA data with 0183 format is connected.

- Select ‘CURS’ or ‘SHIP’ in the FUNCTION menu.
- External data is required for screen display information. (p.38).

When “WPT” is selected;

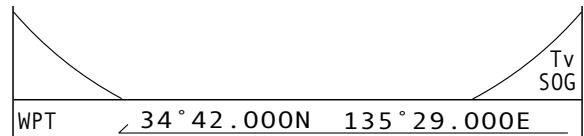

39 WAYPOINT READOUTS (p. 15)

Shows the bearing and distance to the waypoint received from navigation equipment.

- This readout appears when the “WPT” of the FUNCTION menu is selected.
- External data is required for screen display information. (p.38).

40 TIME INDICATOR

Shows the estimated time to the waypoint with current speed.

- External data is required for screen display information. (p.38).

MOB

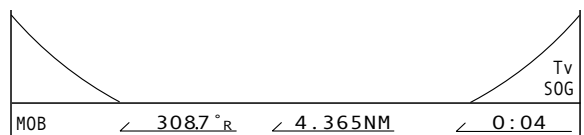

41 MOB READOUTS

Shows the bearing and distance to the MOB (Man Over Board) event marker.

- Push and hold [MOB] for 0.5 sec. to cancel the readout and the symbol.
- When [MOB] function is activated, [MOB] readout is prior to displayed except [EBL/VRM] readouts.
- External data is required for screen display information. (p.38).

■ BRILL MENU

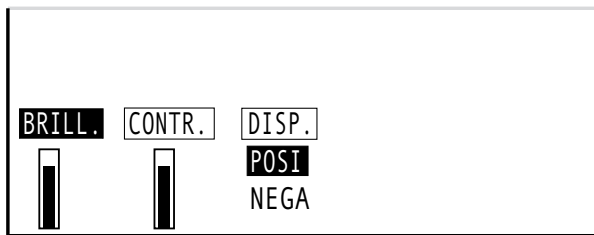

Push [BRILL] to turn the [BRILL] menu ON or OFF.

■ BRILL. (Brilliance)

- Push [<]/[>] to select [BRILL.], then push [^]/[v] to change the setting.

■ CONTR. (Contrast)

- Push [<]/[>] to select [CONTR.], then push [^]/[v] to change the setting.

■ DISP. (Display type)

- Push [<]/[>] to select [DISP.], then push [^]/[v] to select the “Positive display” or “Negative display”.

NOTE:

Pushing and holding [BRILL] for 1 sec, returns the brilliance and contrast setting to the default setting.

■ ADJ(Adjust menu)

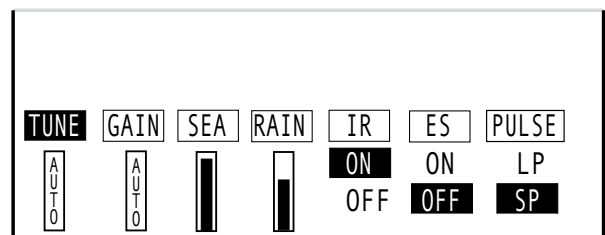

Push [ADJ] to turn the ADJ. menu ON or OFF.

- Push [<]/[>] to select the item and push [UP] or [DOWN] to change the setting.

[TUNE], [GAIN], [SEA] control

- While selecting each item, push and hold [ADJ] for 0.5 sec. to turn the “AUTO function” ON and OFF.

■ TUNE

- “AUTO.TUNE” appears for approx. 5 sec. instead of the screen display, when first transmitting after turning the power on. The unit also re-tunes in some cases.
- When activating the manual tuning slider, push [^]/[v] to adjust desired tuning level.

■ GAIN CONTROL [GAIN] (p. 11)

Adjusts the receiver amplifier gain.

- Increased gain may increase screen noise.

■ SEA CLUTTER CONTROL [SEA] (p. 12)

- This function serves to eliminate echoes from the waves at close range.
- Reduces the receiver gain for close objects within a radius of 8 miles to eliminate sea clutter.
 - Under normal conditions set the SEA to a minimum or AUTO.
 - Use this control with caution when the sea is rough.

■ RAIN CLUTTER CONTROL [RAIN] (p. 12)

This function eliminates reflection echoes from rain, snow, fog, etc.

■ IR (p. 13)

- OFF : Turn the Interference Reduction function OFF.
- ON : Turn the Interference Reduction function ON.

■ ECHO STRETCH [ES] (p. 13)

- OFF : Turn the echo stretch function OFF.
- ON : Turn the echo stretch function ON.

■ PULSE

- LP : Select the long pulse. LP indicator appears on the screen.
- SP : Select the short pulse.

FUNCTION MENU

FUNCTION		
RING	OFF	ON
D. RANGE	NAR.	MID. WIDE
ZONE ALARM	IN	OUT
EBL/PI	TRUE	360 ^R PT/SB
DATA DISP	OFF	CURS SHIP WPT
L/L DISP	OFF	ON
WPT	OFF	ON
OWN VECT	OFF	ON
TRAIL TIME	6MIN	
SAVE TIME	15MIN	

Sample;

• **DATA DISPLAY: OFF**

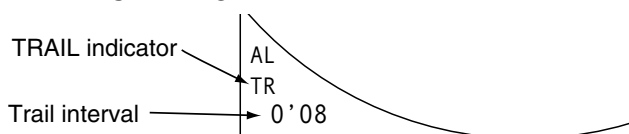

• **DATA DISPLAY: CURS** (Cursor)

CURS	039.8 ^R	2.068NM	0:09
------	--------------------	---------	------

• **DATA DISPLAY: SHIP** (Position)

POSN	34°38.637N	135°33.209E
------	------------	-------------

• **DATA DISPLAY: WPT** (Way Point)

WPT	002.8 ^R	5.628NM	0:14
-----	--------------------	---------	------

• **L/L DISP OFF**

WPT	002.8 ^R	5.628NM	0:14
-----	--------------------	---------	------

• **L/L DISP ON**

WPT	34°42.000N	135°29.000E
-----	------------	-------------

Push [MENU] to turn the [FUNCTION] menu ON.

- Push [^]/[v] to select the item and push [<]/[>] to change the setting.

■ **RING**

- OFF : Turn the fixed range ring display OFF.
- ON : Turn the fixed range ring display ON.

■ **D.RANGE**

Select the dynamic range of the PPI (Plan Position Indicator).

- NAR. : Narrow dynamic range. Even weak reflections are displayed as strong reflections.
- MID. : Mid dynamic range.
- WIDE : Wide dynamic range. You can distinguish between weak reflections and strong reflections easily. It's easy to overlook a quiet weak reflection.

■ **ZONE ALARM**

- IN : Alarm is emitted when the target comes into the zone.
- OUT : Alarm is emitted when the target goes out of the zone.

■ **EBL/PI** (except HDG and CSE) (p. 17)

- TRUE* : True or magnetic direction.
- 360^R : Relative direction
- PT/SB : Bow direction

■ **DATA DISP*** (See left)

- OFF : No information displays on the screen.
- CURS : Display the cursor position.
- SHIP : Display your own ship's position.
- WPT : Display the Way Point.

■ **L/L DISP*** (See bottom left)

- OFF : Display the bearing, distance and time on the screen.
- ON : Display the Latitude and Longitude on the screen [CURS], [WPT] AND [MOB].

■ **WPT***

- OFF : For not displaying the way point mark on the screen.
- ON : To display the way point mark on the screen.

■ **OWN VECT***

- OFF : For not displaying the own ship vector.
- ON : To display your own ship's vector.

■ **TRAIL TIME**

- 15S, 30S, 1M, 3M, 6M, 15M, 30M or ∞ : Select the plot interval and vector time.

■ **SAVE TIME**

- 1M, 6M, 15M or 30M : Select the stand by time during save mode.

* The radar for TX interval scan is fixed at 10 revolutions.

***NOTE:** External data is required for screen display information. (p.38).

■ EPA(Electronic Plotting Aid)

EPA MENU		
EPA	OFF	ON
VECT	TRUE	REL
No.DISP	OFF	SEL ALL
ALARM	OFF	ON
CPA LIMIT	1.0NM	
TCPA LIMIT	10MIN	
INT.SETTING		

Push [MENU] several times to turn the [EPA] menu ON or OFF.

- Push [^]/[v] to select the item and push [<]/[>] to change the setting.

***NOTE:** External data is required for screen display information. (p.38).

■ EPA

- OFF : Turn the EPA function OFF.
- ON : Turn the EPA function ON.

■ VECT

- TRUE : Select the true vector mode.
- REL : Select the relative vector mode.

■ No.DISP

- OFF : For not displaying any mark number.
- Sel : Display the selected mark number only.
- ALL : Display all mark numbers.

■ ALARM (CPA/TCPA)

- OFF : Turn the alarm function OFF.
- ON : Turn the alarm function ON.

■ CPA* LIMIT

- 0.1 to 50.0 NM : Set the CPA (Closest Point of Approach) limit with [<]/[>]keys.

■ TCPA* LIMIT

- 1 to 60 MIN. : Set the TCPA (Time to CPA) limit time with [<]/[>] keys.

*CPA/TCPA: Closest Point of Approach and Time to Closest Point of Approach limit is defined by the observer to give a warning when a target or targets are close to within those limits from your own ship.

■ INT. SETTING

- Push [>] to open the **INT. SETTING** menu. (see right)

■ INT. SETTING

INT. SETTING		
BEEP	OFF	ON
DIST UNIT	NM	KM
BRG	TRUE	MAG
MAG VER	AUTO	MANU. 0.0° E
BRG INPUT	NMEA	N+1 AUX
SPD INPUT	GPS	LOG
TX INH START	0°	
TX INH ANGLE	0°	
SERVICE MAN		

Push [MENU] several times to turn the EPA menu ON.

- Push [∨] to select the [INT.SETTING] and push [>] to open the [INT.SETTING] menu.

■ BEEP

- OFF : Turn the beep tone OFF*.
- ON : Turn the beep tone ON.

* Except alarm function.

■ DIST UNIT

- NM : Display the distance unit as NM.
- KM : Display the distance unit as KM.

■ BRG

Select the displayed bearing type, no relation with the bearing data format (NMEA, N+1 or AUX).

- TRUE : Select the true bearing.
- MAG : Select the magnetic bearing.

■ MAG VAR

- AUTO* : Revise magnetic variation automatically.
*NOTE: NMEA data is required. **NEVER** select "AUTO" without NMEA data, incorrect variation data may entered. (p. 38)
- MANUAL : Revise magnetic variation manually.
 - Push [>] to select [MANUAL], then push [∨]. Set the revised value with [<]/[>]. Push [∨] or [MENU] key to abort the menu.

■ BRG INPUT

- NMEA : NMEA0183 bearing data format.
- N+1 : N+1 data format.
- AUX : Other format.

■ SPD INPUT

- GPS : Use the GPS NMEA speed data.
- LOG : Use the speed sensor data.

■ TX INH START

- 0 to 359° : Push [<]/[>] key to enter the start point of the TX inhibit area.

■ TX INH ANGLE

- 0 to 90° : Push [<]/[>] key to enter the TX inhibit area.

■ SERVICE MAN

- Push [>] to open the **SERVICE MAN** menu.

NOTE: This menu exists for service or maintenance purposes only.

■ Checking the installation

Before turning the power ON, be sure all the connections are complete. The checklist at right may be helpful for necessary confirmation.

CAUTION: Connect the scanner unit before turning the power ON. Otherwise the magnetron inside the scanner unit might be damaged.

•Checklist

- ① The 4 bolts securing the scanner unit must be firmly tightened.
- ② Cabling must be securely attached to a mast or mounting material, and must not interfere with the rigging.
- ③ Be sure waterproofing procedures are completed on the system cable.
- ④ The power connections to the battery must be of the correct polarity.
- ⑤ Be sure that the plugs at the rear of the display unit have been connected correctly and securely.
(See p. 26 for details.)

■ Turning power ON/OFF

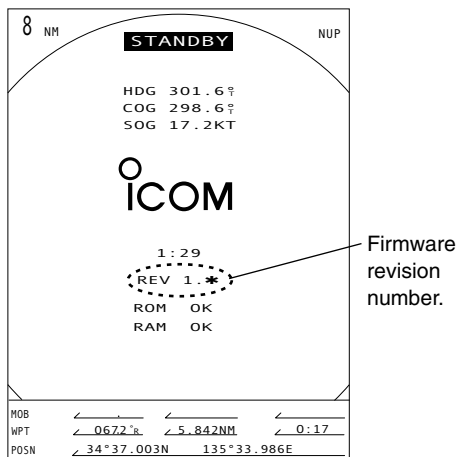

Firmware revision number.

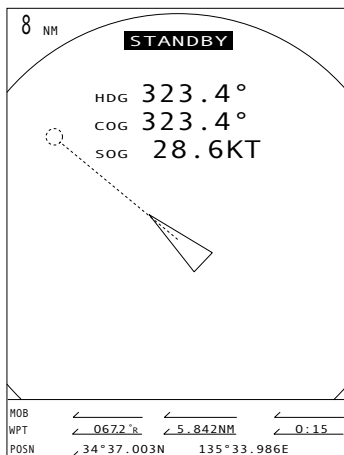

- ① Push [POWER] to turn the power ON.
 - The initial screen appears and warming up time is counted down on the screen.
 - The magnetron inside the scanner unit warms up for 90 sec.
 - The firmware's revision number appears.
 - [POWER] does not function for 2 sec. after the power is turned OFF.
- ② When the countdown is completed, the Standby screen appears.
- ③ Push [TX] to start scanning and select the Plan Position Indicator (PPI) screen.
 - Targets and heading marker appear.
 - The screen appears approx. 5 sec. after turning the power on, when 'AUTO' is selected in the "TUNE" of the FUNCTION menu.
- ④ Push [POWER] to turn the power OFF.

NOTE:

Push [BRILL] for 1 sec. to turn the [BRILL] setting to default, when the "Brilliance" or "Contrast" was miss adjusted.

■ Basic operation

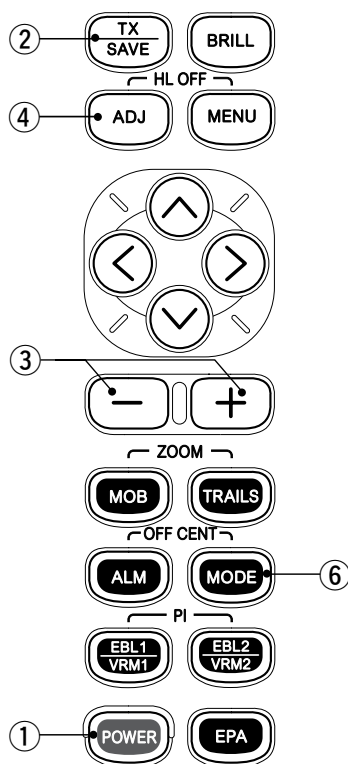

- ① Turn the power ON.
- ② Push [TX] after the countdown disappears from the screen.
 - See “Turning power ON/OFF” on page at left.
- ③ Push [+] or [-] key one or more times to select the display range.
 - The screen range readout shows the maximum range of the screen.
- ④ Push [ADJ] then adjust the [GAIN]* to be on the threshold of max. screen range.
 - Increases the gain.
 - Increased gain may increase screen noise.
- ⑤ Select [SEA]*, then set the [SEA]* to minimum.
- ⑥ Push [MODE] to select one of HUP (Head-up), CUP (Course-up), NUP (North-up) or True motion TM screens.
 - C UP, N UP or TM can be selected only when bearing, position or speed data are connected. (See p. 26 for details)

*Select each item, then push [ADJ] for 0.5 sec. to use auto setting mode.

CAUTION: When setting the [SEA] control to MAX position, close targets are blanked.

• Heading Line marker

The heading marker is a line that shows your ship's bow direction. (This marker will appear in the center of the screen when the Head-up screen H UP is selected.) The heading marker can be hidden when the desired target is located under the heading marker.

- Push and hold [ADJ] and [MENU] simultaneously to hide the heading marker.

• Fixed range rings

The fixed range rings can be used for rough distance measurement. (p. 14)

Push [MENU] to open the FUNCTION menu, then push [∨] to select RING. Push [>] to turn the ring ON.

• Brilliance adjustment

The intensity of the screen can be adjusted. When you require continuous operation, but not constant viewing, a lower setting can increase the life of the backlight.

NOTE: High intensity will shorten the life of the backlight.

• Key illumination

The backlighting of the keys can be adjusted for convenient operation. (p. 6)

- Key illumination corresponds with [BRILL] control.

4 BASIC OPERATION

The followings are typical basic operation examples, which may hinder radar reception (sea clutter, precipitation interference and echoes from other radar).

■ RAIN function

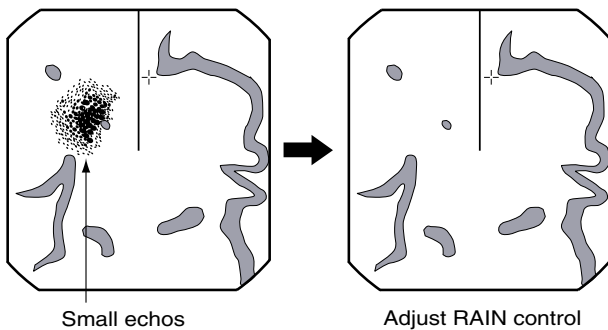

This function eliminates reflection echoes from rain, snow, fog etc.

- Adjust the lowest level to deactivate the control function.
- **NOTE: DO NOT** reduce the reflection echoes too much, otherwise you may miss weaker targets.

■ SEA function

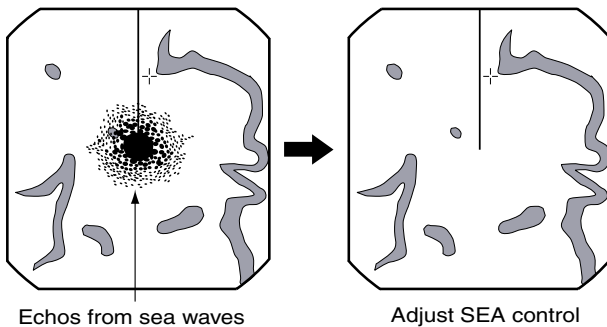

This function serves to eliminate echoes from waves at close range. Reduce the receiver gain for close objects within a radius of 8 miles to eliminate sea clutter.

- Push and hold [ADJ] for 0.5 sec. to activate the automatic control function.

WARNING: The [SEA] control reduces the receiver sensitivity of objects within 8 miles. Therefore, caution and careful adjustment are necessary when using the [SEA] control.

Small objects may not be displayed on the screen when strong echoes from the rain or the island within 1 NM while automatic SEA function is activating.

■ OFF CENTER function

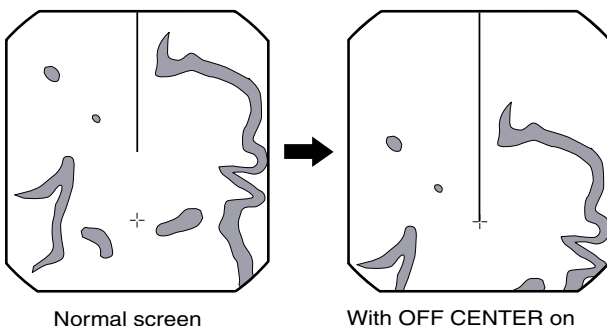

The scanning area can be shifted in a desired direction and can be enlarged partially. This is useful when the Head-up* is selected and you want to enlarge the bow direction display, or, the center of the screen shifts in the direction of the intersection.

- This function is available within, and up to a 24 NM range.
- *This function is not available in the TM screen.

- ① Push [^]/[v]/[<]/[>] key to move the cursor where you want to shift the center of the screen.
 - Max. offsetting is up to 56% of the screen.
- ② Push [ALM] and [MODE] simultaneously to shift the screen.
- ③ Push [ALM] and [MODE] simultaneously again to return to the normal screen.

■ IR function

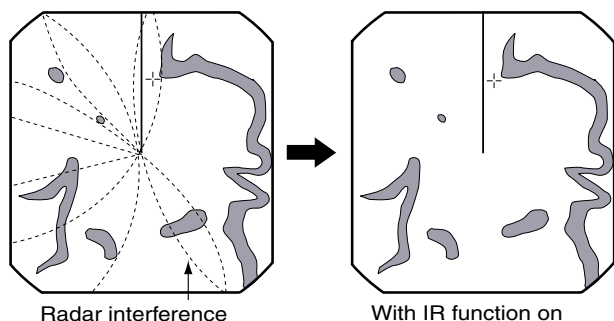

Radar interference may appear when another ship's radar is operating on the same frequency band in close proximity. The IR function can eliminate this type of interference. (p. 6)

- ① Push [ADJ] to call up "ADJUST" menu.
- ② Push [<]/[>] until the "IR" section becomes highlighted.
- ③ Push [^]/[v] to select IR function ON or OFF.

■ ECHO STRETCH function

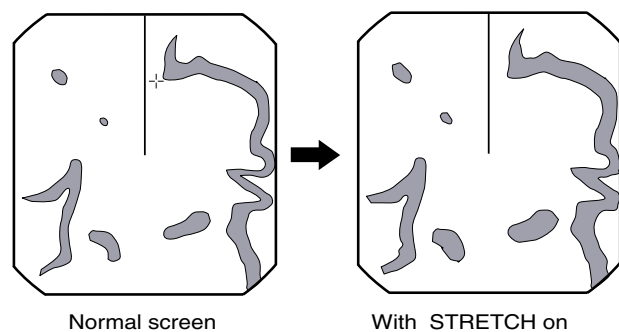

The blips can be magnified electronically for easier viewing of small targets. (p. 6)

- ① Push [ADJ] to open the ADJUST menu.
- ② Push [<]/[>] to select "STRETCH". Push [^]/[v] to turn the function ON or OFF.

NOTE: Turn OFF this function during normal operation.

■ ZOOM function

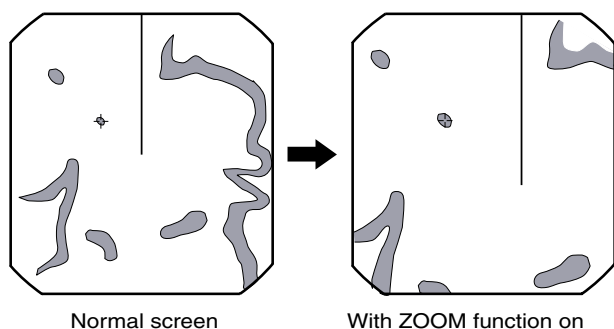

The ZOOM function expands the target to two times normal size.

• This function is available within, and up to a 24 NM range. (except for $\frac{1}{8}$ and $\frac{3}{4}$ NM.)

- ① Push [^]/[v]/[<]/[>] to move the cursor to the desired target.
- ② Push [MOB] and [TRAILS] simultaneously to toggle the "ZOOM" function ON and OFF.

■ TRAILS function

The trails function memorizes echoes continuously or at constant intervals. This is useful for watching other ships' tracks, approx. relative speed, etc.

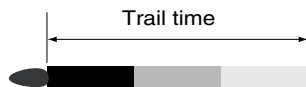
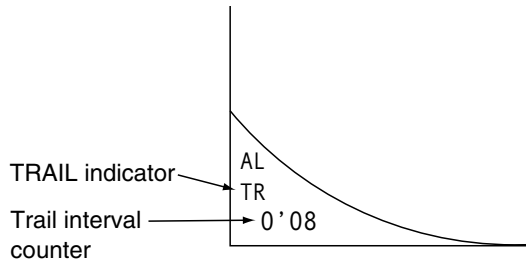

• Setting the trail interval time

- ① Push [MENU] to call up the FUNCTION menu.
 - Push [∨] several times until the "TRAIL TIME" section becomes highlighted.
- ② Push [<]/[>] to select trail interval time.
 - 15 sec., 30 sec., 1 min., 3 min., 6 min., 15 min., 30 min. and ∞ (continuous) are available.
- ③ Push [MENU] several times to exit the menu.

• Using the TRAILS function

- ① Push [TRAILS] to turn the trail function ON.
 - "TRAILS" and trail interval time appears in the lower left of the screen.
- ② All displayed echoes at the plotted time are memorized and displayed with a gradually fading intensity together with the current echoes.
 - Echoes are displayed with minimum intensity when "∞" is selected.
- ③ Push [TRAILS] to cancel the trail function and erase the plotted echoes.
 - "TRAILS" and trail interval time disappears.

■ Power save function

The power save function conserves the boat's battery power by pausing the transmission. The standby (pausing) times are selectable (*rotation number is fixed on 10 rotations).

For example, when 1 min. is selected, the scanner rotates 10 revolutions; then stops for 1 min., and then repeats this sequence while the power save function is activated.

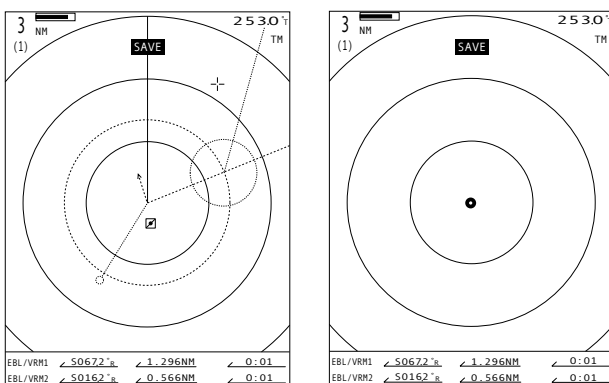

Scan and standby alternates.

• Setting the scanning standby time

- ① Push [MENU] to call up the "FUNCTION" menu.
- ② Push [DOWN] until the "SAVE TIME" section becomes highlighted.
- ③ Push [<]/[>] to select standby time.
 - 1, 6, 15, and 30 min. are available.
- ④ Push [MENU] twice to exit the menu display.

• Using the "POWER SAVE" function

- ① Push and hold [TX (SAVE)] for 0.5 sec. to turn the power save function ON.
 - The save indicator appears in the top of the screen.
- ② After the scanning rotations are finished, transmission and rotation are suspended until the selected standby time elapses.
 - The display shows the last scanned echoes until the scanning restarts.
 - "SAVE" appears in the top of the screen.
- ③ After the selected standby time elapses, transmission and rotation restart.
- ④ Push [TX (SAVE)] to cancel the power save function.
 - The save indicator turns OFF.

NOTE: When you use the power save function together with the alarm function, the LCD display is turned OFF until an object enters the programmed alarm zone, therefore, more power saving is possible. (p. 19)

■ Ship speed indication

When the ship speed data with NMEA 0183 format is applied, the radar can display the ship speed. Knots (KT) or kilometres/hour (KM/h) are automatically selected in the normal screen (p. 00) by selecting nautical miles (NM) or kilometres (KM) respectively.

- ① Push [MENU] to call up the [INT.SETTING] menu.
- ② Push [DOWN] until "DIST UNIT" section becomes highlighted.
- ③ Push [<]/[>] to turn the ship speed indication to NM or KM.
- ④ Push [MENU] to exit the menu display.

■ Position indication

When latitude/longitude data with NMEA 0183 format is applied, the radar can display the latitude and longitude of your ship's or cursor position in the bottom of the display. (To display the "CURSOR" position, bearing data is necessary.) (P. 38)

- ① Push [MENU] twice to call up the "FUNCTION" menu.
- ② Push [√] until "DATA DISP" section becomes highlighted.
- ③ Push [<]/[>] to select SHIP (ship position) or CURS (cursor position).
- ④ Push [MENU] several times to exit the menu.

■ Waypoint indication

When waypoint data received from navigation equipment with NMEA 0183 format is applied, the radar can display the waypoint. To display the waypoint marker, bearing data is necessary. (p. 38)

- ① Push [MENU] twice to call up the "FUNCTION" menu.
- ② Push [√] until the "DATA DISP" section becomes highlighted.
- ③ Push [<]/[>] to select WPT (Waypoint).
- ④ Push [MENU] twice to exit the menu display.

■ Long pulse function

To magnify the blips for easier viewing of small targets, the long pulse and echo stretch (p. 11) functions are available. When the long pulse is used in the $\frac{3}{4}$ to 2 NM range, this function magnifies target echoes to the backward direction of the target.

• Pulse selection

- ① Push [ADJ] to call up the Adjust menu. (p. 6)
- ② Push [<]/[>] until the "PULSE" section becomes highlighted.
- ③ Push [^]/[∨] to select the long pulse.
- ④ Push [ADJ] to exit the menu.

NOTE: Turn ON the SP (Short Pulse) function during normal operation. This function reduces the target distance resolution. (p. 6).

■ Bearing setting

The radar bearing interface accepts NMEA, N+1 or AUX data format and the bearing can be used as a magnetic or true north type. When a true north type bearing is used, the variation from magnetic north, etc., can be adjusted on 0.1° steps.

• Setting the bearing type

- ① Push [MENU] twice to call up "EPA" menu.
- ② Push [√] several times and push [>] to call up the [INT. SETTING] menu.
- ③ Push [√] until the "BRG" section becomes highlighted.
- ④ Push [<]/[>] to select magnetic or true north type.
 - All displayed bearing readouts show the selected bearing type.

• Setting the magnetic variation

- ① Push [√] until the "MAG VAR" section becomes highlighted.
- ② Push [<]/[>] to select an "AUTO*" or "MANU." variation.
- ③ When a "MANU." variation is selected, push [DOWN], then push [<]/[>] to set the bearing variation.
- ④ Push [MENU] to exit the menu display or push [√] once to proceed to the bearing input setting.

***NOTE:** NMEA data is required for auto variation. **NEVER** select "AUTO" variation without NMEA data. Incorrect variation data may entered. (p. 38)

Distance measurement

Two measurement procedures are available with this radar. Operating them separately or jointly is possible.

The distance unit, nautical miles (NM) or kilometres (KM) is selected in the "INIT.SETTING" menu (p. 9).

TYPE	DESCRIPTION
RING	Displays fixed rings. Suitable for rough estimations from your own ship to any target.
VRM1	Displays a variable range marker. Suitable for accurate measurements from your own ship to a target.
VRM2	When the VRM1 and EBL1 selects a target, the center of VRM2 appears at the intersection point. Suitable for accurate measurements from target to target.

Using the fixed rings

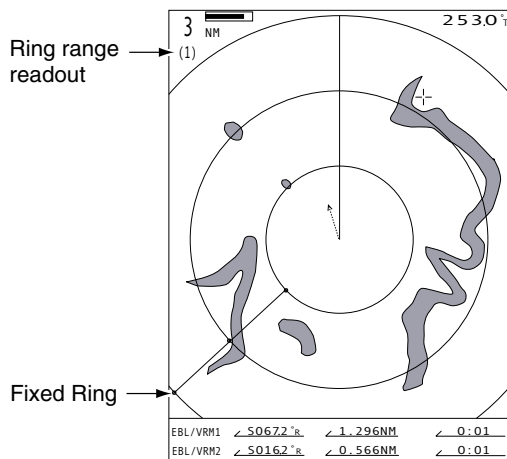

- Push [MENU] to call up the "FUNCTION" menu.
- The "RING" section becomes highlighted.
- Push [>] to select "RING" function ON then display the fixed ring.
 - The interval range appears on the right of the screen range readout.
 - The ring range is fixed depending on the screen range. (See below.)
- Push [MENU] several times to exit the menu.
- To clear the fixed rings, push [<] to select OFF in step ③ above.

Range (nm)	1/8	1/4	1/2	3/4	1	1.5	2	3	4	6	8	12	16	24	32	36
Ring (nm)	1/16	1/8	1/8	1/4	1/4	1/2	1/2	1	1	2	2	4	4	8	8	12
Number	2	2	4	3	4	3	4	3	4	3	4	3	4	3	4	3

NOTE: When the screen is shifted, the number of rings may differ.

Using the variable range marker

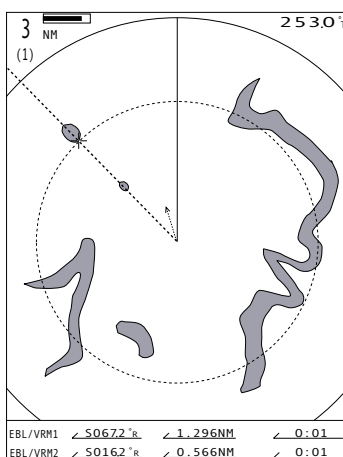

- Push [^]/[v]/[<]/[>] several times to move the cross line cursor on the target.
- Push [EBL1 (VRM1)] to display EBL1 and VRM1.
- Push [EBL1 (VRM1)] again to cancel EBL1 and VRM1.

■ Bearing and Distance measurement

This radar has 2 Electronic Bearing Lines (EBL) to indicate the target direction from your ship or a target.

• Using the EBL and VRM-1

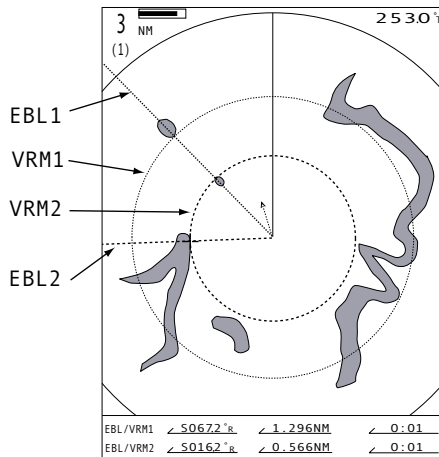

• Using the EBL and VRM-2

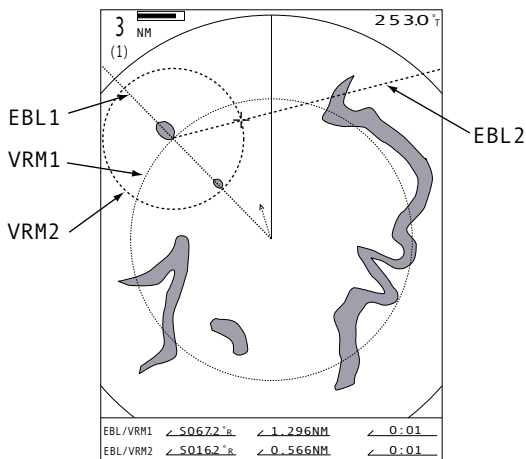

• Using the variable range marker

- ① Push [^]/[v]/[<]/[>] several times to move the cross line cursor on the target.
- ② Push [EBL1 (VRM1)] to display the EBL1 and VRM1.
 - The EBL1 and VRM1 readouts indicate the target bearing and distance.
 - The EBL readouts indicate the target bearing;
 - 0 to 360°R: Relative direction, when '360°R' is selected in the EBL/PI of the "FUNCTION" menu. (p. 7)
 - P/S 0 to 180°: Bow direction, when 'PT/SB' is selected in the EBL/PI of the "FUNCTION" menu. (p. 7)
 - 0 to 360°T*: True or magnetic bearing, when selecting 'TRUE' in the EBL/PI of the "FUNCTION" menu. (p. 7)

* Bearing data is required. (p. 38)

- ③ Push [^]/[v]/[<]/[>] several times to move the cross line cursor on the another target.
- ④ Push [EBL2 (VRM2)] to display the EBL2 and VRM2.
 - The EBL2 and VRM2 readouts indicate the target bearing and distance.
- ⑤ Push [EBL2 (VRM2)] once more to display the EBL2 and VRM2 from the intersection point of the VRM1 and EBL1.
 - When the [EBL2 (VRM2)] is pushed again, the center of VRM2 appears at the intersection point of the EBL1 and VRM1.
- ⑥ Push [EBL2 (VRM2)] to clear the EBL2 and VRM2 indication.
 - Push [EBL1 (VRM1)] to clear EBL2/VRM2 and EBL1/VRM1 at the same time.
- ⑦ Push [EBL1 (VRM1)] to clear EBL1 and VRM1.

NOTE: EBL2 and VRM2 will not be displayed on the screen when VRM2 readout exceeds 20 times as long as the screen range.

- The EBL2 and VRM2 readouts indicate remain on the screen.

Advanced measurements

Using both Electronic Bearing Lines (EBL) and both Variable Range Markers (VRM), the following advanced measurements can be made:

Measuring the distance and direction between 2 targets

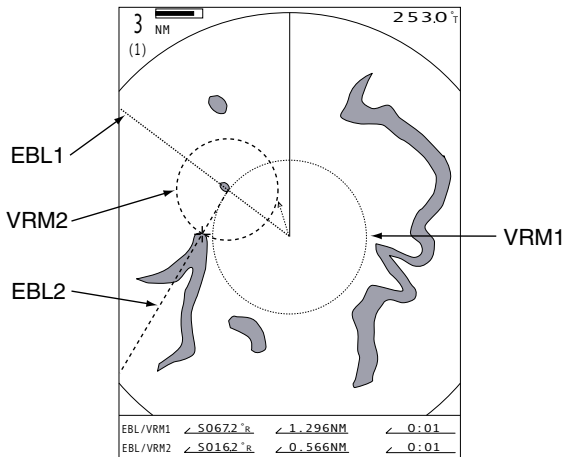

- ① Push [^][v][<][>] to move the cross line cursor on the desired target.
- ② Push [EBL1 (VRM1)] to display the EBL1 and VRM1.
- ③ Push [^][v][<][>] to move the cross line cursor on the next target.
- ④ Push [EBL2 (VRM2)] to display the EBL2 and VRM2.
- ⑤ Push [EBL2 (VRM2)] once more to display the EBL2 and VRM2.
 - The intersection of the EBL1 and VRM1 becomes the center of the EBL2 and VRM2.
- ⑥ The VRM2 readout shows the distance between the two targets. The EBL2 readout shows the direction from one target to the other.

Measuring the relative speed and course of a target

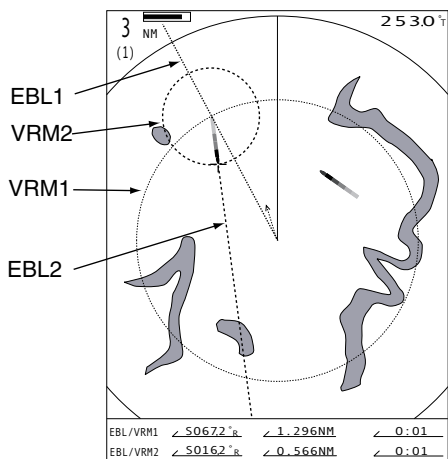

- ① Push [TRAILS] (p. 12) ON; then wait until the trail time count up reaches to the TRAIL TIME.
- ② Set VRM1 and EBL1 to a previously plotted target as described above.
- ③ Set VRM2 and EBL2 to the current plotted position of the same target as described as above.
- ④ The VRM2 readout is a measurement of target movement which can be converted into relative target speed.
 - For example, when a 6 min. trail time is selected, multiplying the distance by ten gives the relative average speed of the target.
 - If your ship is stationary during the plotting time, the converted speed and direction become absolute.
 - The converted speed unit is knots or kilometres/hour when the selected unit in the “FUNCTION” menu is nautical miles (NM) or kilometres (KM), respectively.
- ⑤ The EBL2 readout shows the course direction of the target.

The unit has an alarm function to protect your ship from collisions. If other ships or islands, etc. come into the pre-programmed alarm zone, the function alerts you with an alarm. You can set the desired range and bearing for an alarm zone. While the alarm function is activated, the power save function turns the LCD OFF until an alarm is given, to conserve power.

Alarm zone setting

Setting and using the alarm function

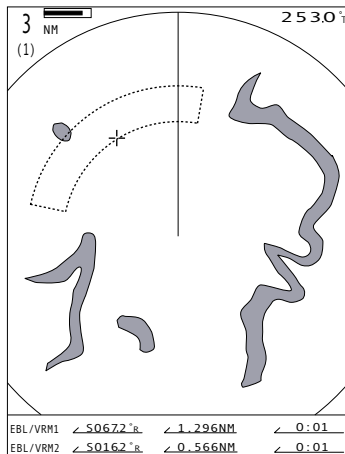
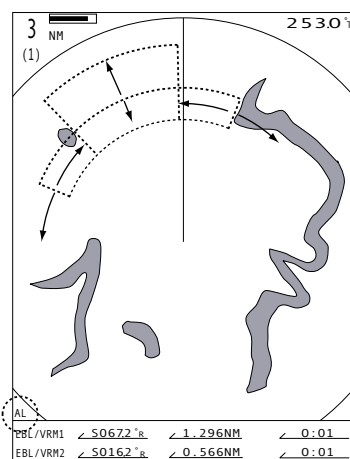

Fig. 1

Push
[<] [>] [^] [v]



“AL”
appears

Fig. 2

- ① Push [+] / [-] to select the desired range.
- ② Push [^] / [v] / [<] / [>] to set the cursor to the starting point of the alarm zone.
- ③ Push and hold [ALM] for 0.5 sec. to enter the alarm zone setting.
 - The starting zone appears on the screen. (Fig. 1)
- ④ Push [<] / [>] to adjust an angle and push [^] / [v] to set the distance of the alarm zone.
 - The selected alarm zone appears.
- ⑤ Push [ALM] to fix the alarm zone and activate the alarm function.
 - “AL” appears on the bottom of the screen.
 - The selected alarm zone remains.
- ⑥ If a target comes into or goes out of the alarm zone, an alarm beep is emitted.
 - Push [ALM] to cancel the alarm signal and function .
- ⑦ To deactivate the alarm function, push [ALM].
 - “AL” and alarm zone disappear from the screen.
- ⑧ To activate the alarm function again with the same programmed zone, push [ALM].
 - “AL” and pre-programmed alarm zone appears.

Using the function with power saver

To activate the power save function, push and hold [TX (SAVE)] for 0.5 sec. while the alarm function is turned ON.

- The LCD display turns OFF.
- When a target comes into the alarm zone, an alarm signal is emitted, the LCD display turns ON and the power save function is cancelled.

Zone alarm setting

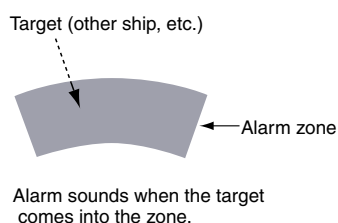

Fig. 3

Zone alarm beep is emitted when the target comes into the zone, or the target goes out of the zone.

- ① Push [MENU] to call up the FUNCTION menu.
- ② Push [v] until the “ZONE ALARM” section becomes highlighted.
- ③ Push [<] / [>] to select IN or OUT
 - IN : Alarm sounds when the target comes into the zone. (Fig. 3)
 - OUT : Alarm sounds when the target goes out of the zone.

■ EPA (Electronic Plotting Aid)

The EPA (Electronic Plotting Aid) for manual plotting is interfaced for small ships fitted with a gyrocompass, speed and distance measuring equipment.

EPA (Electronic Plotting Aid), will in order to improve the standard of collision avoidance at sea, reduce the workload of the crew by enabling them to obtain information about plotted targets, as well as they could by manually plotting a single target themselves.

- Max. 10 targets can be plotted on the screen.
- Plot positions shall be identified by an approved symbol mark (p. 22) and associated plot number.
- The vector origin will move across the screen at a rate and direction defined by the calculated true or relative course and speed.
- The vector will be displayed on the target.
- External data is required for screen display information. (p.38).

■ EPA menu setting

Set the EPA menu items before using the EPA function.

EPA MENU		
EPA	OFF	ON
VECT	TRUE	REL
No. DISP	OFF	SEL ALL
ALARM	OFF	ON
CPA LIMIT	1.0NM	
TCPA LIMIT	10MIN	
INT. SETTING		

- ① Push [MENU] several times to turn the EPA menu ON.
- ② Push [LEFT] to turn the EPA function ON
- ③ Push [✓] to select "VECT"; push [<]/[>] to select the vector type.
 - TRUE (True vector):
The predicted true motion of a target as the result of your own ship's direction and speed input.
 - REL (Relative vector):
The predicted movement of a target relative to your own ship.
- ④ Push [DOWN] to select "No. DISP" to select the target identification number type which appears at the right side of the mark. Push [<]/[>] to select the appropriate type.
 - OFF: No number appears.
 - SEL: Number appears by the selected mark only.
 - ALL: All numbers appear by the marks.
- ⑤ Push [DOWN] to select "ALARM"; push [<]/[>] to turn the alarm function ON or OFF.
 - EPA alarm is emitted when both CPA and TCPA reaches the limit.
- ⑥ Push [✓] to select the "CPA* LIMIT"; push [<]/[>] to set the CPA limit distance.
- ⑦ Push [✓] to select the "TCPA* LIMIT", push [<]/[>] to set the TCPA limit time.

*CPA/TCPA: Closest Point of Approach and Time to Closest Point of Approach limit is defined by the observer to a given warning when a target or targets are close to within those limits from your own ship.

- ⑧ Push [MENU] to exit the EPA menu.

■ EPA operation

Set menu				
	CORR	CLR	ALL CLR	
No. 1	BRG	337.3 [°]	DIST	2.041NM
	CSE		SPD	
0'45	CPA		TCPA	

Identification No.	Bearing	Course	Distance	Speed
No. 1	BRG	337.3 [°]	DIST	2.041NM
	CSE	248.5 [°]	SPD	18.6KT
0'45	CPA	2.004 NM	TCPA	4'25
	Closest Point of Approach		Time to Closest Point of Approach	
	Vector time			

Select the target which you want to plot on the display.

- ① Push [^]/[v]/[<]/[>] to move the cursor on the desired target.
- ② Push [EPA] to display the EPA information screen.
 - “SET” menu appears below the screen.
 - “SET” becomes highlighted.
- ③ Push [EPA] to select the target for plotting.
 - Dotted square symbol appears on the cursor.
 - Target identification number, bearing and distance read-out appears in the information screen.
 - Timer starts to count the progressing time.
- ④ Push [^]/[v]/[<]/[>] to move the cursor on the desired target.
- ⑤ Push [EPA] to display the “SET” menu, after the progressing time of 30 sec. has passed.
- ⑥ Push [^]/[v] to select the appropriate target number.
 - “SET” becomes highlighted.
- ⑦ Push [EPA] to register the target.
 - Target course (CSE) and speed (SPD) appears on the data screen.
 - CPA and TCPA of the target appears on the data screen.
 - The vector appears on the target.
- ⑧ Push [EPA] for 0.5 sec. to exit the EPA menu.
 - Target vector remains on the screen.
 - The warning information blinks at the center of the display, and a warning beep is emitted when the plot is not updated for 10 min.
 - The plot will be cleared if the time between consecutive plots exceeds 15 min.
 - Automatically applied ‘target identity numbers’ can not be re-used until the maximum number of plotted targets has been used first.

■ Correct the target

•Correct the uncalculated target

You can correct the uncalculated target by pushing the [EPA] until the progressing time reaches 30 sec.

- ① Push [^]/[v]/[<]/[>] to move the cursor on the proper target.
- ② Push [EPA] to display the EPA information screen.
- ③ Push [^]/[v] to select the desired target number.
 - “CORR” becomes highlighted.
- ④ Push [EPA] to correct the target position.
 - Progressing counter restarts again.
 - Push [>] to select “CLR” to clear the current mark.
 - Push [>] twice to select “ALL CLR” to clear all marks.
- ⑤ Push and hold [EPA] for 0.5 sec. to exit the EPA menu.

•Reset the calculated target

When the target turns, reduces speed, increases speed or stops after calculating, the vector will not show the actual predicted position. In such case you must reset the vector and position of the target, otherwise the EPA alert may not function properly.

- ① Push [^]/[v]/[<]/[>] to move the cursor on the proper target.
- ② Push [EPA] to display the EPA information screen.
- ③ Push [^]/[v] to select the desired target number.
 - “SET” becomes highlighted.
- ④ Push [EPA] to correct the target vector and position.
 - Progressing counter restarts again.
 - Push [>] to select “CLR” to clear the current mark.
 - Push [>] twice to select “ALL CLR” to clear all marks.
- ⑤ Push and hold [EPA] for 0.5 sec. to exit the EPA menu.

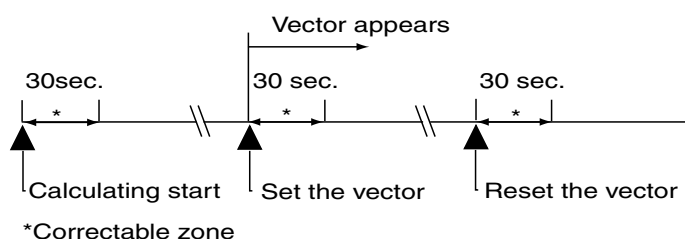

Clear the target

You can clear the unnecessary target vector.

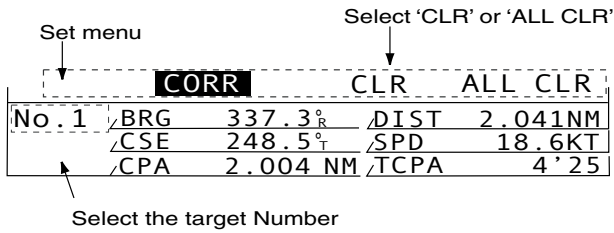

- ① Push [EPA] to display the EPA information screen.
- ② Push [^]/[v] to select the desired target number.
- ③ Push [>] to select "CLR" to clear the current mark.
 - Push [>] twice to select "ALL CLR" to clear all marks.
- ④ Push and hold [EPA] for 0.5 sec. to exit the EPA menu.

NOTE: Automatically applied 'target identity numbers' cannot be re-used until the maximum number of plotted targets has been used first.

Plotting marks

There are 5 kinds of plotting marks.

- : Selected, uncalculated mark
- : Selected, calculated mark.
- : Normal, uncalculated mark
- : Normal, calculated mark.
- : CPA/TCPA alarm mark. The target is close to within a minimum range and time.
- : Alarm emit indicator. Push [EPA] to cancel the alarm.

Course and speed vector

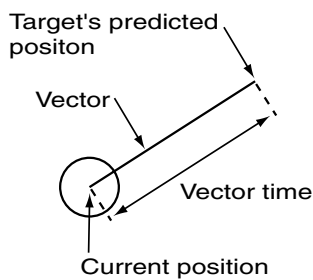

The vector indicates the target's predicted, true or relative course and speed.

- Vector time may change depending on the TRAIL TIME setting. (see FUNCTION menu, p. 7)
- The tip of the vector shows the target's predicted position after a certain time, which has been selected in the "TRAIL TIME".

Plots

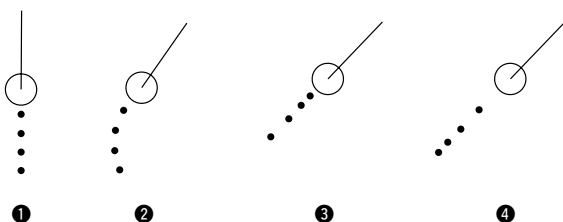

Plot displays past position of targets every 1 min. as 4 dots.

- ① Target goes straight.
- ② Target turns right.
- ③ Target reduces speed
- ④ Target increases speed.

Radar uses a form of electromagnetic radiation, which like light, can be reflected. Because of this property, some objects may cause false echoes on the screen where in fact no targets actually exist.

■ Side-lobe echoes

Radiation can escape on each side of the beam inside the lobes. If a target reflects this radiation, it will be displayed on the screen as an echo.

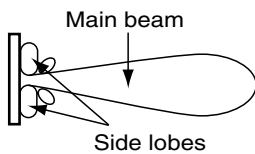

These echoes may appear if a large vessel, bridge, or tank is in proximity. Operators should be familiar with the effects of these phenomena. In some cases, echoes can be reduced.

Side-lobe echoes usually occur at short ranges and as a result of large (strongly reflective) targets. They can be reduced with proper adjustment of the [SEA] control. See p.10 for the [SEA] control.

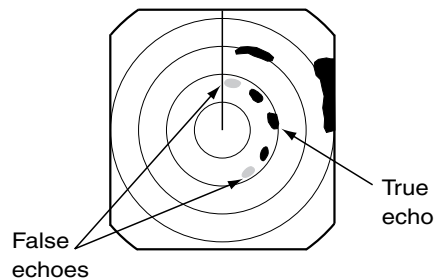

■ Indirect echoes

Indirect echoes may be returned from either a passing ship, or returned from a reflecting surface, such as a mast on your own ship.

An indirect echo from a reflecting surface will appear on a different bearing from the direct (true) echo, but the distance will be approximately the same for both.

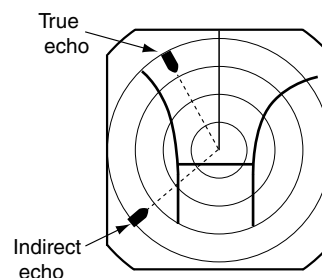
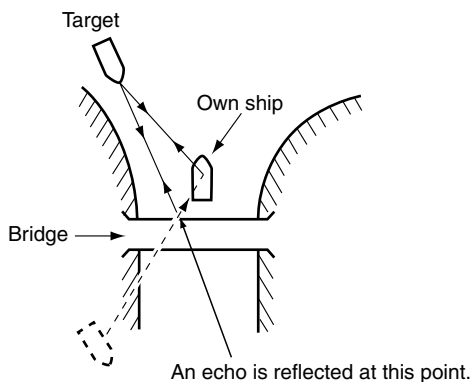
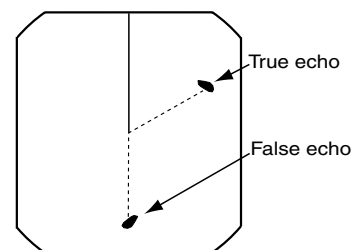
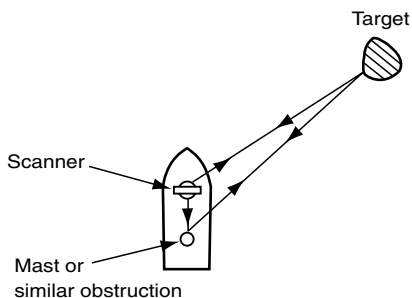

Multiple echoes

Multiple echoes may appear when a short-range and strong echo is received from a ship, bridge, or break-water.

Multiple echoes will appear beyond the target's true echo point on the same bearing of a large target. They can be reduced with proper adjustment of the [SEA] control. See p. 10 for the [SEA] control.



Minimum range

Detection at short range is very important. Minimum range is determined primarily by transmitter pulse length, vertical beam width and height of the scanner unit. The shorter the transmission time, the quicker the return echoes can be received and their distance measured.

The ability to see targets very close to the ship is decreased if the scanner unit is mounted too high off the water, because the bottom of the vertical beam of the scanner cuts off nearby targets.

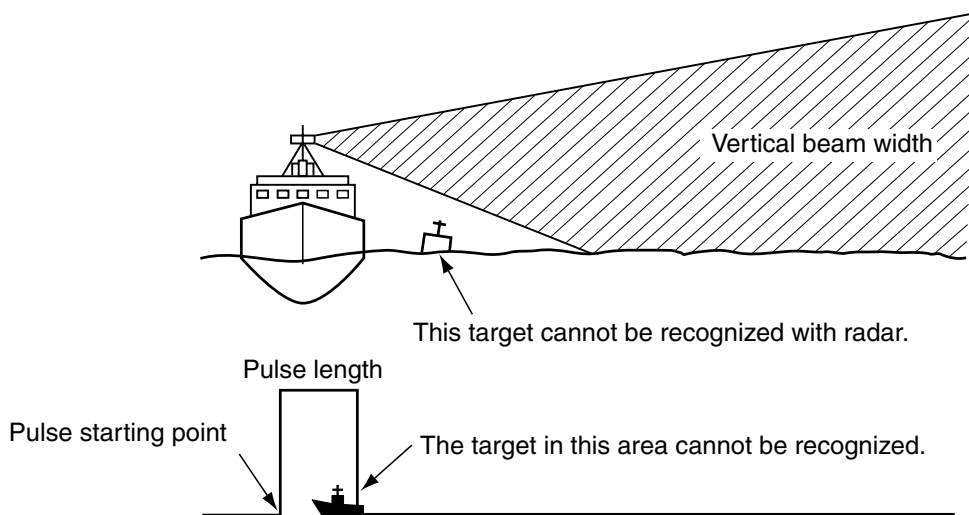

Blind and Shadow sectors

Blind or Shadow sectors may exist because of obstructions such as masts, derricks or stacks. An obstruction may throw either a complete or partial shadow as shown in the diagram below. If a target is in a shadow sector, target echoes may not appear on the screen.

When tall and massive targets such as a large island are located at close range is also shadowed without producing any echoes. This phenomenon is called blind sector. It is very important to know the bearings and widths of all shadow sectors caused by your own ship's obstructions.

Shadow sector

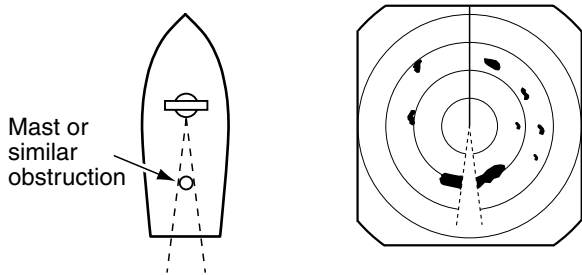

Blind sector

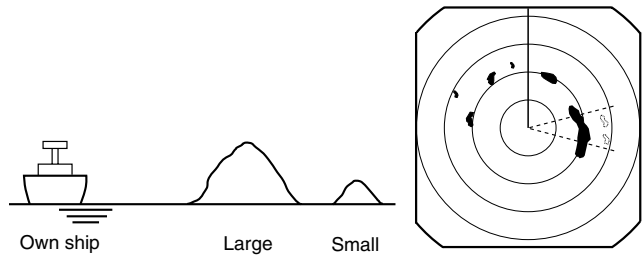

Target resolution

Target resolution is determined by the horizontal beam width and transmit pulse width. Sometimes it is difficult to detect two targets which are separated by short distances or which are in the same direction.

Distance resolution

When two targets are separated by more than the pulse width, they appear as two echoes.

When two targets are not separated by more than the pulse width, they appear as 1 echo.

Direction resolution

When two targets are separated by more than the horizontal beam width, they appear as two echoes.

When two targets are not separated by more than the horizontal beam width, they appear as one echo.

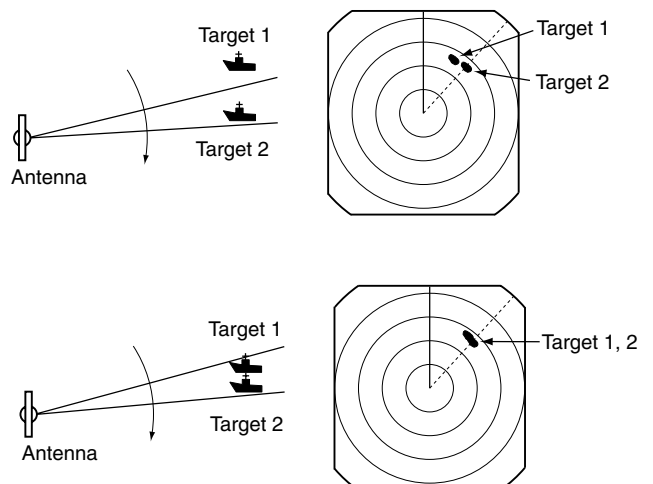
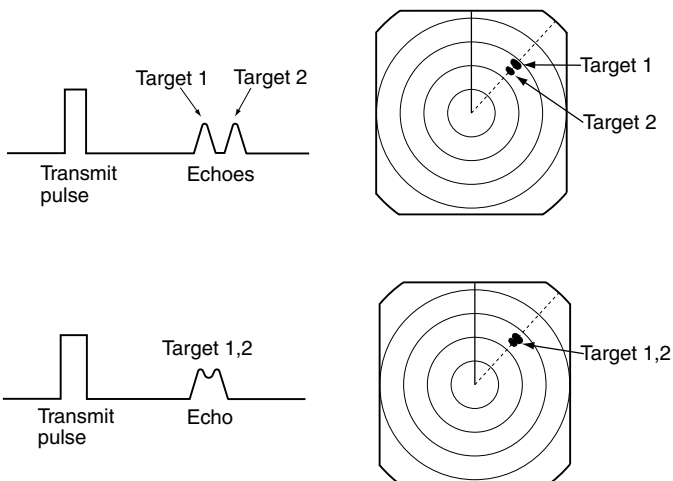

■ Connecting the units

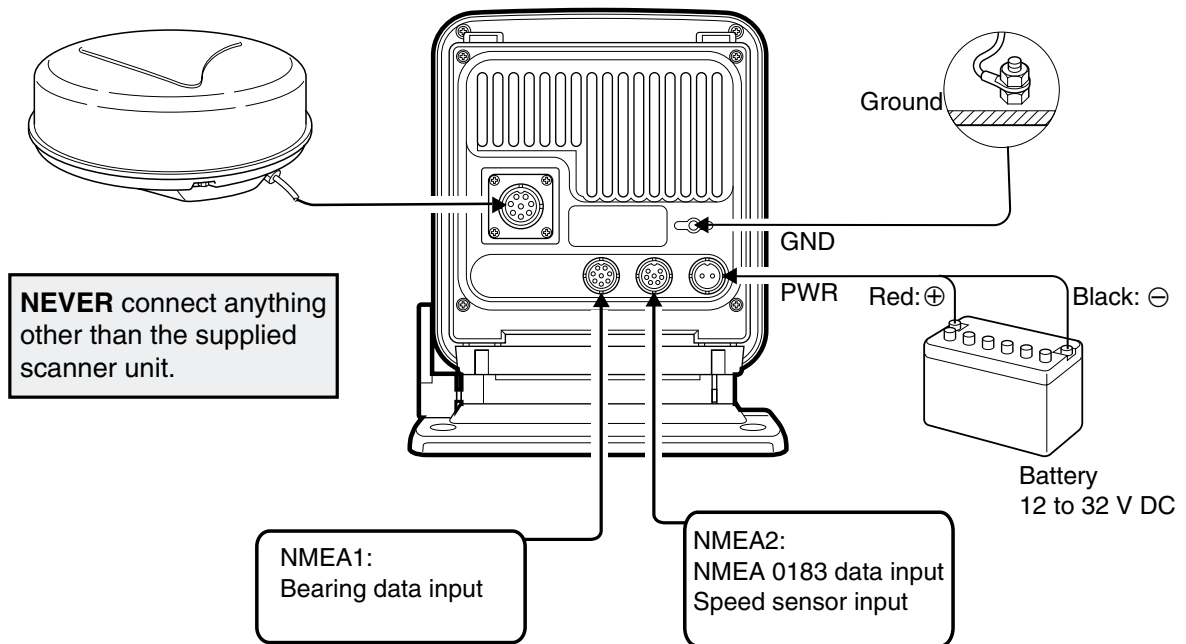

NMEA1 connection

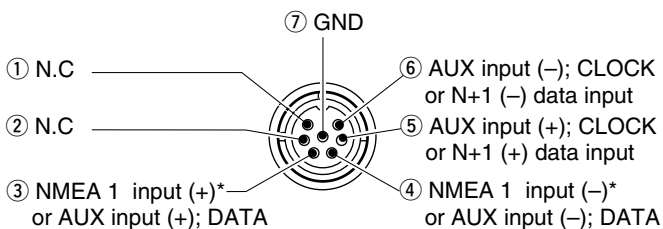

NMEA2 connection

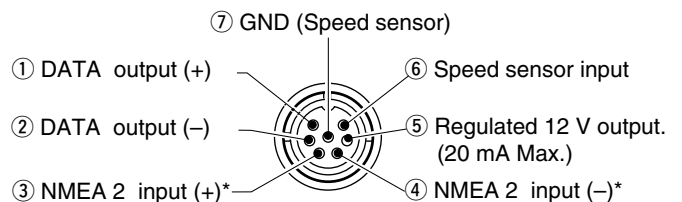

*NMEA input impedance: 500 Ω

■ Power source requirement

• DC power source

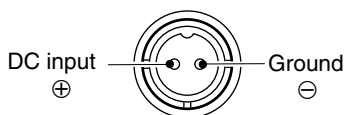

CAUTION: Incorrect cable connection may damage the radar.

The radar is designed for connection to any power source if the voltage is 10.2–42 V DC, so that a 12, 24, or 32 V DC battery can be used without a DC-DC converter, or any internal modifications.

• DC power cable connection

Attach the supplied ferrite core (see p. 30), then connect the supplied DC power cable as shown in the diagram above.

■ Ground connection

To prevent electrical shocks and other problems, ground the display unit through the [GND] terminal on the unit's rear panel. For best results, connect a heavy gauge wire or strap to the nearest grounding point on the boat. The distance between the [GND] terminal and the ground point should be as short as possible.

■ Installing the EX-2473 display unit

• Location

Select a place for installation which meets the following important conditions.

- ① The display unit should be placed near the wheel in the cabin so that an operator may easily view the radar screen while facing the bow.
- ② To minimize interference, **KEEP** the unit **AT LEAST THE COMPASS SAFE DISTANCE** stated in the serial No. seal on the rear panel away from the compass and navigation receiver.
- ③ Select a position where there is no danger of salt or fresh water spray or immersion.
- ④ Select a location where it is easy to perform maintenance or adjustment after installation.
- ⑤ Select a location which can support the weight of the display unit.
- ⑥ **DO NOT** select areas subject to extreme heat, cold, vibrations or direct sunlight.

• Mounting

The stand supplied with the display unit allows “dash-board” or “overhead” mounting.

- ① Hold the stand of the display unit up to the selected location and mark pilot holes for the 4 installation holes using the template.
 - The template is provide on p. 43.
- ② Drill 4 holes of 3.6 to 4.0 mm (5/32 in) in diameter.
- ③ Secure the stand with the self-tapping screws, spring washers, flat washers, flat washer spacers and mounting rubbers. (see below Fig.)
- ④ Mount the display unit onto the stand and secure it with two mounting screws.
- ⑤ Push the tilting lever down and adjust the angle of the unit as appropriate; then return the lever to the original position.

• Dimensions

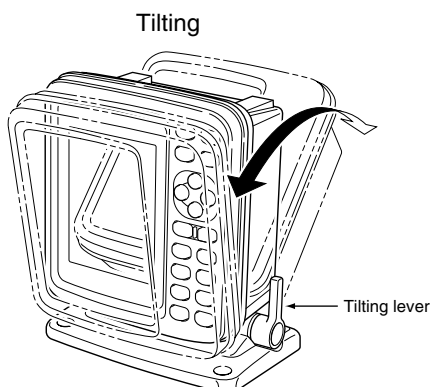
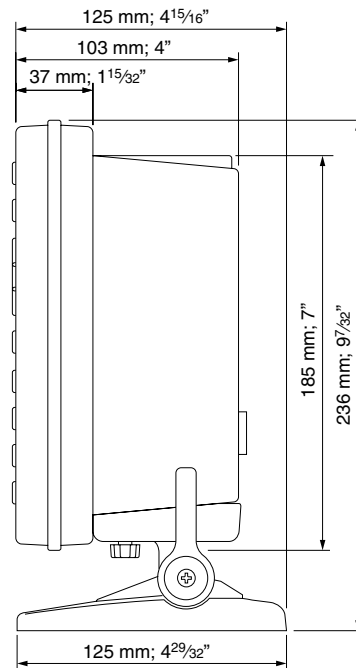
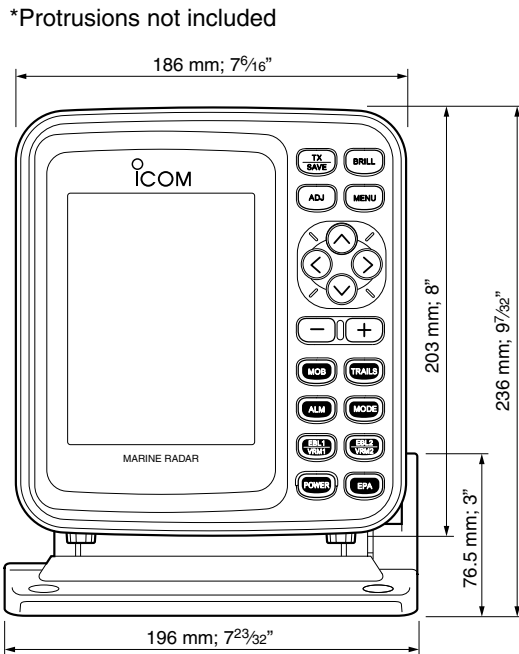

Removing the unit from the stand

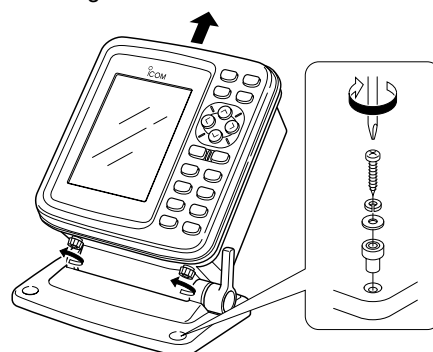

■ Mounting the EX-2474 scanner unit

• Location

WARNING: BE SURE [POWER] is OFF whenever you are working with the scanner unit.

The scanner unit is designed to be weatherproof and completely watertight. Select a place for installation which meets the following important conditions.

- ① The scanner unit must be near the boat's center line and have a good view in every direction. Be sure there are no objects in the surrounding area which will intercept the scanning beam.
- ② **KEEP** the scanner unit away from any smokestacks. Smoke can damage the unit.
- ③ When the boat is equipped with a radio directional finder (RDF) system, keep the scanner unit at least 2 m (6.6 ft) away from any RDF antenna.
 - Radiation from the scanner unit can affect the measurement data of RDF equipment.
- ④ The unit should be placed as high as possible on the boat to obtain best performance with maximum range.
- ⑤ If you install two or more radar in one boat, install one above, and one below.
- ⑥ The mounting surface must be parallel with the boat's waterline.
- ⑦ If the height is insufficient to install the scanner unit, build a special frame for installation.

• Mounting

- ① Drill four holes of 12 mm (1/2 in) in diameter using the template.
 - The template is provided on p. 41.
- ② If the mounting surface or platform is metal, apply sealing compound around the holes to prevent corrosion and to waterproof the unit.
- ③ Fix the scanner unit to the selected position with bolts of 10 mm (3/8 in) in diameter, with flat and spring washers. The supplied bolts are two lengths: 25 mm (1 in) or 50 mm (2 in).

CAUTION: SECURE the four bolts tightly.

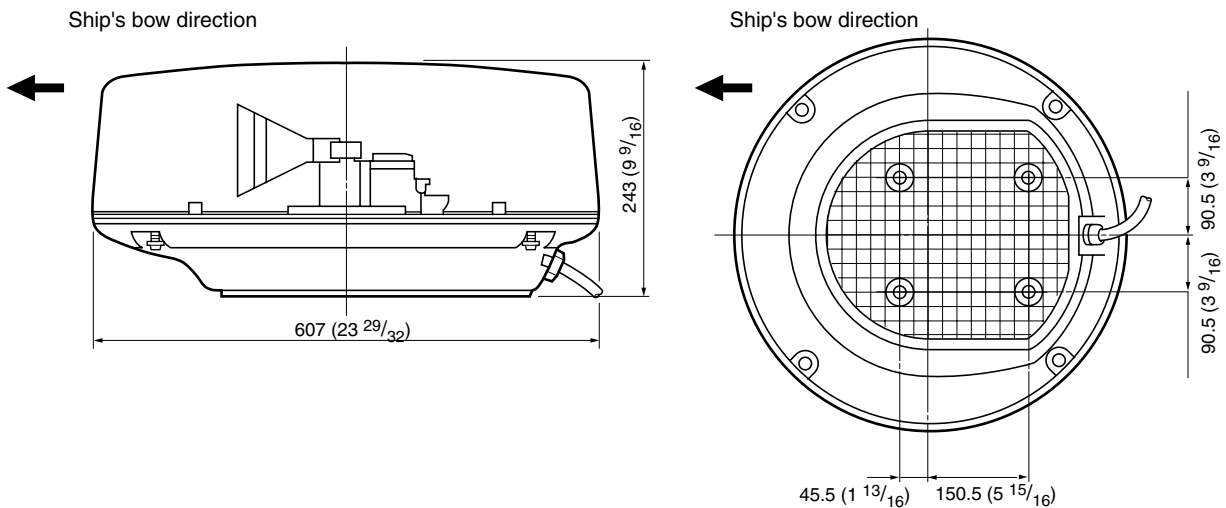

Unit: mm (in)

■ Wiring the EX-2474 system cable

CAUTION: DO NOT cut the supplied system cable.

- ① Loosen the four bolts using a hex head wrench on the bottom of the scanner unit, and open the unit.
- ② Loosen the nut on the scanner unit and pass the system cable through the nut and sealing tube.
- ③ Loosen the six screws on the IF unit. Then pull and remove the cover.
- ④ Insert the IF cable (black and white) connector to the IF unit connector J3. (*1; Be sure to follow the following diagram carefully)
- ⑤ Replace the IF unit cover to the proper position, then tighten the nine screws.
- ⑥ Connect the shielding wire to the ground plate with the screw as shown in the diagram.
- ⑦ Clamp the system cable with the ferrite core attached near the sealing connector. Be sure to clamp it tightly.

- ⑧ Connect the power cable (black and red) end to the power unit connector. (*2; Be sure to follow the following diagram carefully.)
- ⑨ Tighten the sealing-nut, then replace the radome cover over the scanner unit.
DO NOT stretch the system cable too much, otherwise miss contact of the connector may occur.
- ⑩ Tighten the four bolts on the bottom of the scanner unit.
 - The four projections around the circumference of the radome cover show the positions of the bolt receptacles.

•Scanner unit disassembly

•Connect the system cable

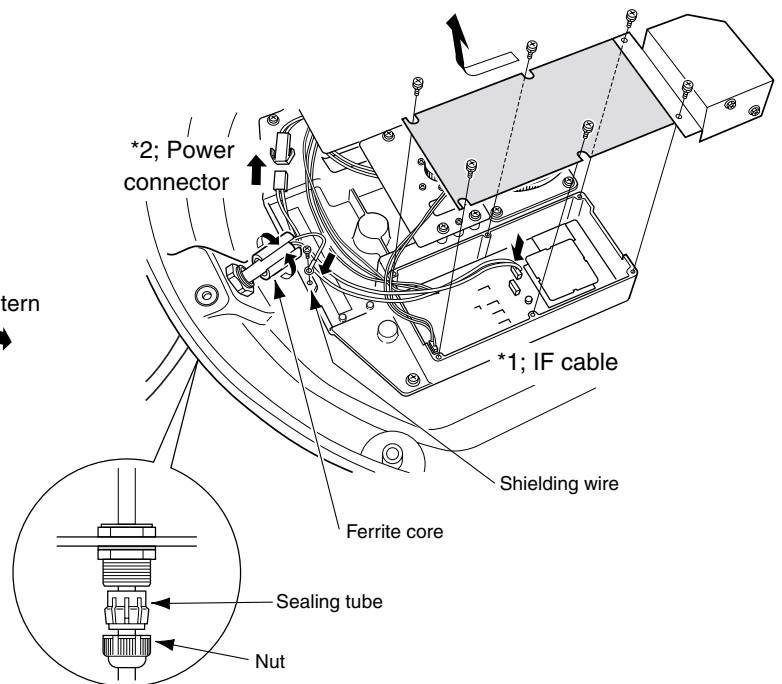
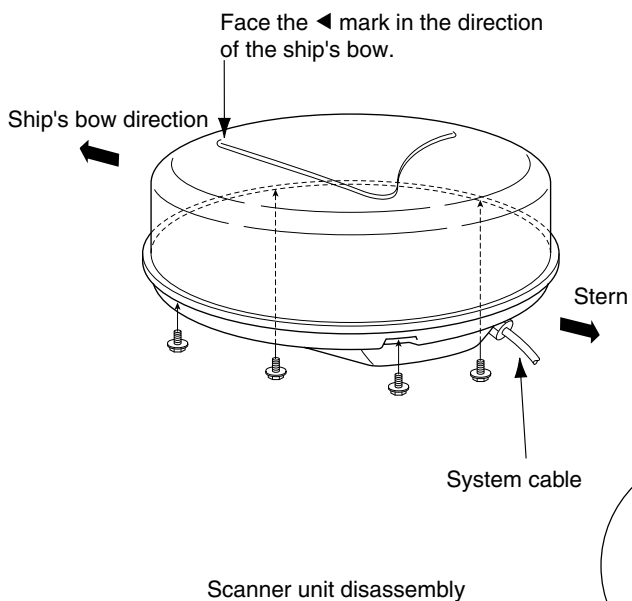

9 INSTALLATION AND CONNECTIONS

◇ Ferrite core attachment

- Attach the supplied ferrite core to the DC power cable as illustrated below.

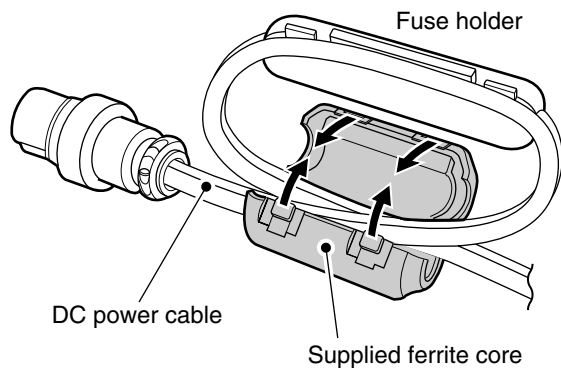

■ Service man menu

ENGLISH	한글	中文	ESPAÑOL	PORTUGS
SPD ADJ.	24000	OUTPUT VOLT.	30.2	
HDG ADJ.	0.0°	HV	349	
TIMING ADJ.		MONITOR	47	
MBS SET		HEATER	0.53	
TUNE PRESET		MG	0.0	
TUNE SET		TX TIME		
T.METER SET			1.2H	
1/8	1/2	1	2	4
1/4	3/4	1.5	3	6
				8
				12
				16
				24
				32
				36

CAUTION: The SERVICE MAN MENU is available for service purposes only. **DO NOT** change any setting on the menu, otherwise the equipment may not operate at it's original performance.

■ Select the language

Menu screens can be displayed in 5 different languages.

Selectable languages •ENGLISH, •KOREAN, •CHINESE, •SPANISH, •PORTUGUESE.

After opening the “SERVICE MAN” menu;

- ① Push [^] to show the present language.
- ② Push [<]/[>] to select desired language, then push [v] to continue the setting.
- ③ Push [MENU] to exit the “SERVICE MAN” menu.

To open the “SERVICE MAN” menu.

- ① Push [MENU] several times to show the “EPA” menu.
- ② Push [v] to select “INT. SETTING”, then push [>] to show the “INT. SETTING” menu.
- ③ Push [v] to select “SERVICE MAN”, then push [>] to open the “SERVICE MAN” menu.

■ SPD ADJ.

- Enter the pulse rate of the speed sensor.

■ HDG ADJ.

- Adjusts the electronic heading line adjustment.

■ TIMING ADJ.

- Corrects the distance.

■ MBS SET

- Adjusts the MBS.

■ TUNE PRESET

- Pre-adjust the objects for clarity on the screen above the 6 NM range.

■ TUNE SET

- Adjusts the object more clearly.

■ T.METER SET

- Adjusts the tuning level indication to the max. level.

■ RANGE

- $\frac{1}{8}$, $\frac{1}{4}$, $\frac{1}{2}$, $\frac{3}{4}$, 1, 1.5, 2, 3, 4, 6, 8, 12, 16, 24, 32, 36
- : Choose the selectable screen range.

■ Other readouts

- OUTPUT VOLTAGE: Shows the voltage level for the scanner unit from the display unit.
- HV (High voltage): Shows the voltage level in the high-voltage unit in the scanner unit.
- MONITOR: Shows the voltage level for checking the receiver unit operation.
- HEATER: Shows the heater current.
- MG: Shows the current level for the Magnetron.
- TX TIME: Shows the total transmitted time.

■ SPD adjustment

- ① Push [MENU], [∨]/[>] several times to display the “SERVICE MAN” menu.
- ② Push [∨] until the “SPD ADJ.” section becomes highlighted.
- ③ Push [<]/[>] to enter the pulse rate (pulse numbers per one mile) of the speed sensor unit.
- ④ Push [MENU] to return to the normal screen.

■ HDG adjustment

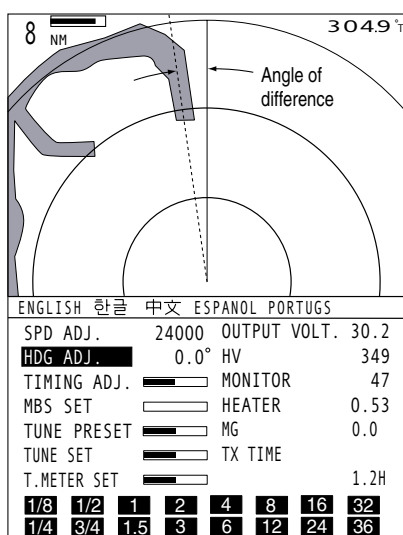

Push [<]/[>]

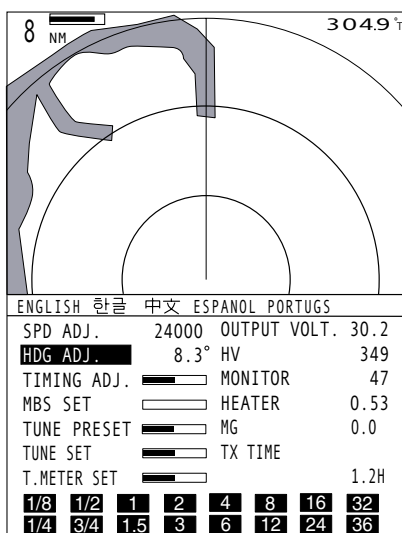

If the heading marker line differs from the exact bow direction, correct the heading marker line as follows. This function may be helpful when the scanner has not been mounted exactly in the direction of the bow.

- ① Line up the bow of the boat with an identifiable target.
- ② Push [TX] to display the target on the screen.
- ③ Push [MENU], [∨]/[>] several times to display the “SERVICE MAN” menu.
- ④ Push [∨] until the “HDG ADJ.” section becomes highlighted.
- ⑤ Push [<]/[>] to adjust, until the target matches the heading marker. (the difference can be read out on the menu screen)
- ⑥ Push [MENU] to return to the normal screen.

■ TIMING adjustment

The system cable length affects the sweep timing. When the cable length adjustment is not correct, a straight target is shown as a curved echo. Thus, cable length adjustment is necessary.

- ① Position your boat near a straight target such as breakwater, wharf, etc.
- ② Push [–] several times to select 1/8 or 1/4 NM range.
- ③ Push [TX] to display the target on the screen.
- ④ Push [MENU], [∨]/[>] several times to display the “SERVICE MAN” menu.
- ⑤ Push [∨] until the “TIMING ADJ.” section becomes highlighted.
- ⑥ Push [<]/[>] to adjust the echo until it becomes straight. (see below)
- ⑦ Push [MENU] to return to the normal screen.

Proper adjustment

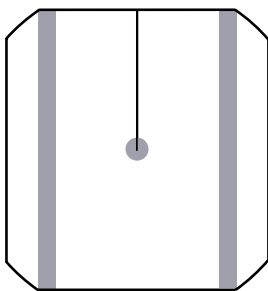

Improper, pulling inward

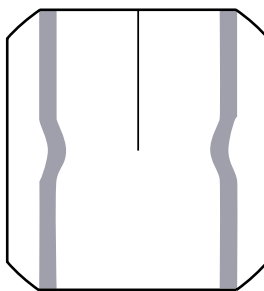

Improper, pushing outward

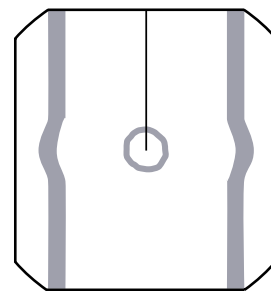

■ MBS adjustment

CAUTION:

In the case, when you re-adjust MBS adjustment from the minimum position, AUTO TUNE (Automatic tuning) function may not tune properly.

NOTE: While pushing and holding [MOB] and [TRAILS], push [POWER] to activate the ‘Tuning adjustment’ setting.

- ① Push [–] several times to select the 1/4 NM range or shorter. Push [MENU], [∨]/[>] several times to display the “SERVICE MAN” menu.
- ② Push [∨] until the “MBS” section becomes highlighted.
- ③ Push [<]/[>] to adjust so that the echo of near by objects are discerned with maximum definition.
- ④ Push [MENU] to return the normal screen.

RANGE selection

ENGLISH 한글 中文 ESPANOL PORTUGS	
SPD ADJ.	24000 OUTPUT VOLT. 30.2
HDG ADJ.	0.0° HV 349
TIMING ADJ.	MONITOR 47
MBS SET	HEATER 0.53
TUNE PRESET	MG 0.0
TUNE SET	TX TIME
T.METER SET	1.2H
1/8 1/2 1 2 4 8 16 32	
1/4 3/4 1.5 3 6 12 24 36	

*4 NM range will be skipped.

- ① Push [MENU], [∨]/[>] to display the “SERVICE MAN” menu.
- ② Push [∨] until the “→” appears on the screen.
- ③ Push [∧]/[∨] to choose the selectable screen ranges with [+] or [-] keys on the display.
- ④ Push [<] to skip from the range selection, or push [>] to cancel skipping.
- ⑤ Push [MENU] to return to the normal screen.

Selectable ranges: 1/8, 1/4, 1/2, 3/4, 1, 1.5, 2, 3, 4, 6, 8, 12, 16, 24, 32, 36 (NM)

Tuning adjustment

Tuning level indicator

Tuning level

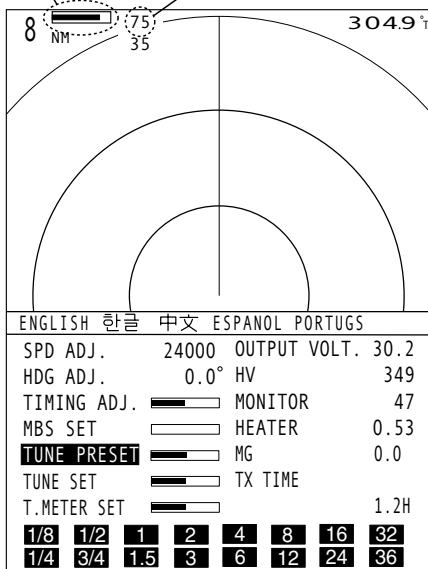

NOTE: While pushing and holding [MOB] and [TRAILS], push [POWER] to activate the ‘Tuning adjustment’ setting.

- ① Push [MENU], [∨] and [>] to display the “SERVICE MAN” menu.
- ② Push [+] several times to select the 6 NM range or longer.
- ③ Push [<]/[>] to adjust a “TUNE SET” to the center position.
- ④ Push [∧]/[∨] to select “TUNE PRESET”.
- ⑤ Push [<]/[>] to adjust a comparatively weak echo for maximum definition.
- ⑥ Push [∨] to select the “T.METER SET”.
- ⑦ Push [<]/[>] to adjust a tuning level to show that it is at peak level. (see left)
- ⑧ Push [MENU] to return to the normal screen.
 - **DO NOT** change the screen range before returning to the normal screen.

NOTE: When returning to the normal screen, the tuning level indicator automatically adjusts to 85% of the full scale.

Auto gain adjustment

NOTE: While pushing and holding [MOB] and [TRAILS], push [POWER] to activate the ‘Auto gain’ setting.

- ① Push [+] several times to select the maximum range. Then push [TX].
- ② Push [ADJ] for 0.5 sec. to turn the Adjust setting to manual control.
- ③ Push [∧]/[∨] to adjust the gain to the point where noise just begins to appear on the screen.
- ④ Push [ADJ] for 2.5 sec. to complete the adjustment.
 - Beep tone “Pi pi” emits.

■ Error message list

Message	Condition
BRG INPUT FAIL* ¹	•The Azimuth signal is interrupted. An alarm tone is emitted within 5 sec. and the display reverts to H UP mode in approx. 1 min.
TRIG SIGNAL FAIL* ¹	• If the TRIGGER signal is interrupted for more than 15 sec., an alarm tone is emitted.
SHM SIGNAL FAIL* ²	• If the SHM signal is interrupted for more than 15 sec., an alarm tone is emitted.
VIDEO SIGNAL FAIL* ²	• If the VIDEO signal is interrupted for more than 15 sec., an alarm tone is emitted.
POSN INPUT FAIL* ¹	• If the position signal is interrupted for more than 15 sec., an alarm tone is emitted.
NO. XX TARGET IS NOT UPDATED* ³	• The plot will be dropped if the time between consecutive plots exceeds 15 min.
CHECK SCANNER CONNECTION* ⁴	•The system cable may not be connected properly.
CHECK "SERVICEMAN MENU" DATA* ²	•Turn the power off and consult your dealer or service man, as soon as possible.

*¹ Push any key to cancel the error message and beep tone. Turn the power OFF, then check the external data cable connection.

*² An electricity failure may occur, turn the power OFF, then consult your dealer or service man.

*³ Push any key to cancel the error message and beep tone.

*⁴ Turn the power OFF, then check the system cable connections.

12 MAINTENANCE

Continued, reliable operation of the radar depends on how you care for your equipment. The simple maintenance tips that follow can help you save time and money, and avoid premature equipment failures.

■ Periodic maintenance

WARNING: BE SURE the power is **OFF** before performing any maintenance.

- ① Keep the equipment as clean as possible.
 - Use a soft cloth to remove dirt, dust and water.
- ② Check all hardware for loose screws, bolts, etc.
- ③ Check cables and terminal connections.

■ Scanner unit maintenance

WARNING: BE SURE the power is **OFF** before working on the radar.

•Cleaning

- ① Wipe the surface of the scanner with a clean soft cloth.
 - **DO NOT** use strong solvents such as benzene or alcohol.
- ② Check that there is no drift or caked salt.
 - A heavy deposit of dirt or caked salt on the painted surface of the upper scanner unit will cause a considerable drop in radar performance.
- ③ Check for cracks or deterioration of the rubber packing and replace it if necessary.

•Mounting

Check the mounting bolts of the scanner unit and tighten if necessary.

■ Display unit maintenance

WARNING: BE SURE the power is **OFF** before working on the radar.

•Cleaning

Dirt on the LCD will, in time, leave a film of contaminants which tend to dim the picture.

- ① Wipe the surface of the display unit with a clean soft cloth.
 - **DO NOT** use strong solvents such as benzene or alcohol.
- ② If the picture is still dim, clean the LCD screen.

■ Options

•OPC-1076 SYSTEM CABLE

Allows you to install the display unit and scanner up to 15 m (49 ⁷/₃₂ ft) apart.

•OPC-1077 SYSTEM CABLE

Allows you to install the display unit and scanner up to 20 m (65 ⁵/₈ ft) apart.

•OPC-1078 SYSTEM CABLE

Allows you to install the display unit and scanner up to 30 m (98 ⁷/₁₆ ft) apart.

General

- Minimum range : 25 m; 82 ft (when measurement range is $\frac{1}{8}$ NM)
- Maximum range : 36 NM (when measurement range is 36 NM)
- Measurement range : $\frac{1}{8}$, $\frac{1}{4}$, $\frac{1}{2}$, $\frac{3}{4}$, 1, 1.5, 2, 3, 4, 6, 8, 12, 16, 24, 32, 36, (NM)
- Preheat time : 90 sec.
- Connection length between display and scanner unit : 10 m; $32\frac{13}{16}$ ft. (standard), 15 m; $49\frac{7}{32}$ ft (optional), 20 m; $65\frac{5}{8}$ ft (optional), 30 m; $98\frac{7}{16}$ ft (optional)

Scanner unit

◆ EX-2474

- Type : 2 feet Slotted Waveguide Array, enclosed in a radome.
- Rotation speed (typical) : 24 rpm, 36 rpm, 48 rpm (typ.)
- Beam width (typical) : Horizontal beam 4° (typ.)
Vertical beam 22° (typ.)
- Side lobe (typical) : -18 dB
- Polarization : Horizontal
- Transmission frequency : 9410 MHz \pm 30 MHz PON
- Peak output power : 4 kW
- Pulse width : 80 nS/2880 Hz, 80 nS/2160 Hz, 250 nS/2160 Hz, 350 nS/2160 Hz, 900 nS/720 Hz.
- Mixer and Local Oscillator : Microwave Integrated Circuit
- Transmitting Tube : Magnetron MAF1421B
- Modulator : FET switching
- Duplexer : Circulator
- Intermediate frequency : Automatic/manual selectable
- IF : 60 MHz
- IF Band width : 10 MHz, 3 MHz
- Dimensions : 607 (Ø) x 243 (H) mm
- Usable temperature range : -25°C ~ +70°C; -13°F ~ 158°F
- Relative Humidity : Less than 95% at 35°C (+95°F)
- Weight : 9 kg; $19\frac{27}{32}$ lb (without cable)

Display unit

◆ EX-2474

- LCD display : 5.7-inch MONO LCD display
- Pixels : 320 x 240 dot
- Input : NMEA 0183 format (for navigation receiver) ; N+1 format (flux gate compass sensor), AUX
- Power supply requirement : 10.2 ~ 42 V DC
- Power consumption (at wind velocity zero) : Approx. 47 W
- Usable temperature range : -15°C ~ +55°C; +5F ~ 131°F
- Relative humidity : Less than 95% at 35°C (+95°F)
- Dimensions : 186 (W) x 203(H) x 103(D) mm; $7\frac{5}{16}$ (H) x 8 (W) x $4\frac{1}{16}$ (D) inch
- Weight : 2 kg; $4\frac{13}{32}$ lb

All stated specifications are subject to change without notice or obligation.

14 EXTERNAL DATA LIST

The following external bearing, speed, position and way point data is (are) required , when you use the radar functions.

			EXTERNAL DATA INPUT			
			NMEA1*2		NMEA2*2	
			"HDT", "HDM" N+1, AUX		"RMC", "GGA", "GLL", "VTG", "WPL", "BWC", LOG	
FUNCTION		DISPLAY	BEARING	SPEED	POSITION	WAY POINT
HEAD UP		HU				
COURSE UP		CU	Required			
NORTH UP		NU	Required			
TRUE MOTION	OG*1	TM	Required		"RMC", "GGA" or "GLL"	
	TW*1	TM	Required	LOG		
SPEED DISPLAY	OG*1	SOG		"RMC" or "VTG"		
	TW*1	STW		LOG		
HEADING BEARING		HDG	Required			
WAY POINT		WPT	Required		"RMC", "GGA" or "GLL"	"WPL" or "BWC"
OWN VECTOR	OG*1		Required	"RMC" or "VTG"		
	TW*1		Required	LOG		
MOB		MOB	Required		"RMC", "GGA" or "GLL"	
EPA	OG*1	EPA	Required	"RMC" or "VTG"		
	TW*1	EPA	Required	LOG		
VRM/PI/WPT/MOB estimated time of arrival	OG*1			"RMC" or "VTG"		
	TW*1			LOG		
MAGNETIC VARIATION (AUTO)				"RMC" or "VTG"		

*1 OG; Over ground, TW; Through the water.

*2 NMEA1 and NMEA2 connectors; See p. 26.

•"HDT", "HDM", "RMC", "GGA", "GLL", "VTG", "WPL" and "BWC" are SENTENCES of the NMEA0183.

• EX-2473 TEMPLATE

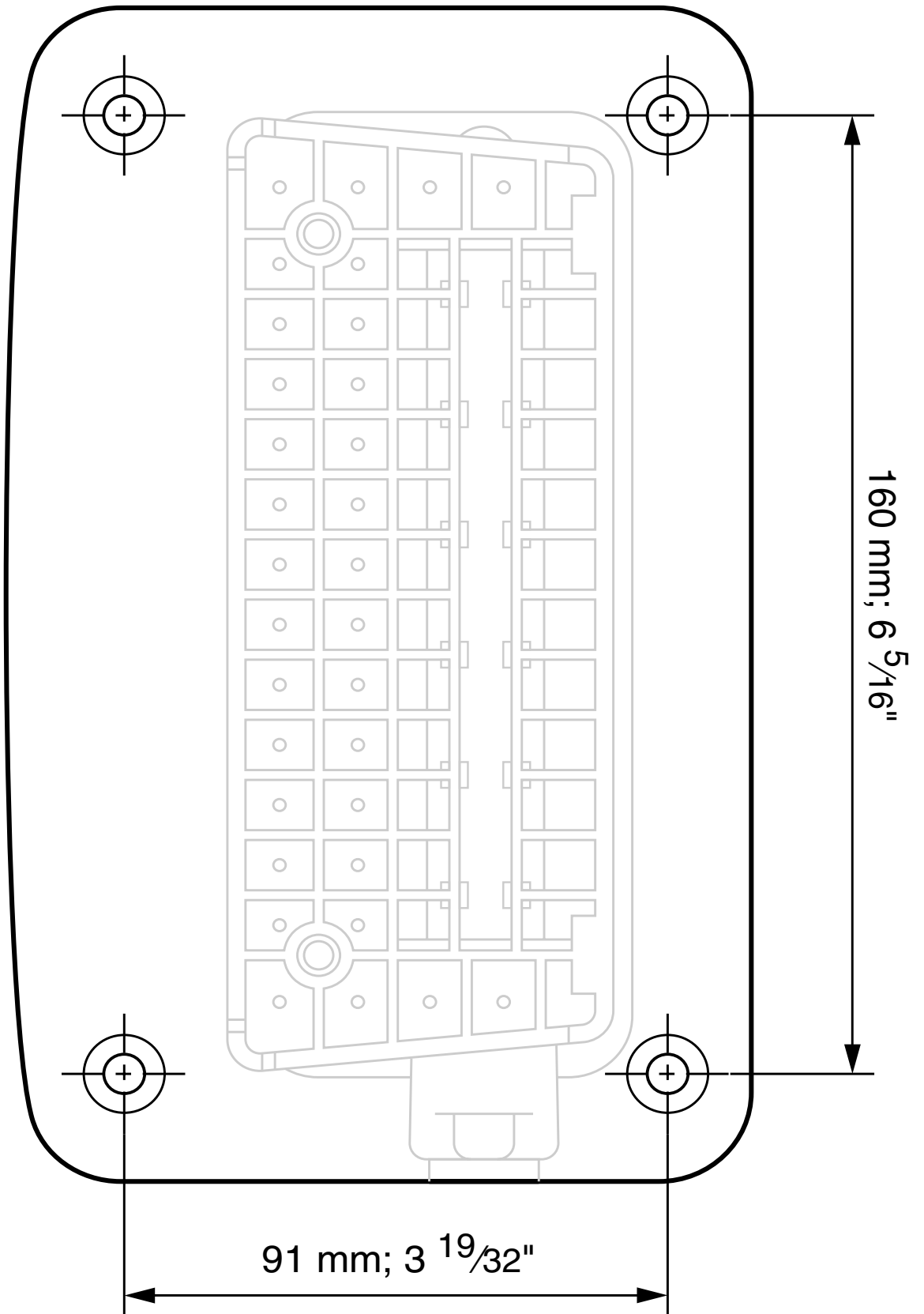

•EX-2474
Scanner unit
template

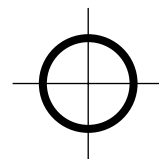
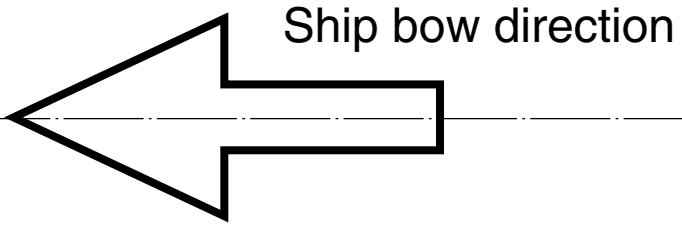
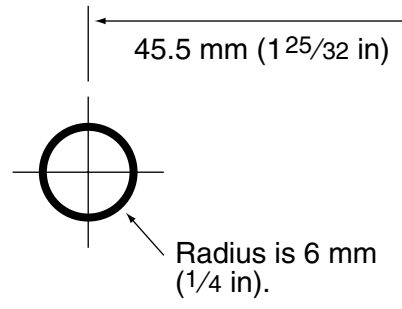

150.5 mm (5¹⁵/₁₆ in)

90.5 mm (3⁹/₁₆ in)

90.5 mm (3⁹/₁₆ in)

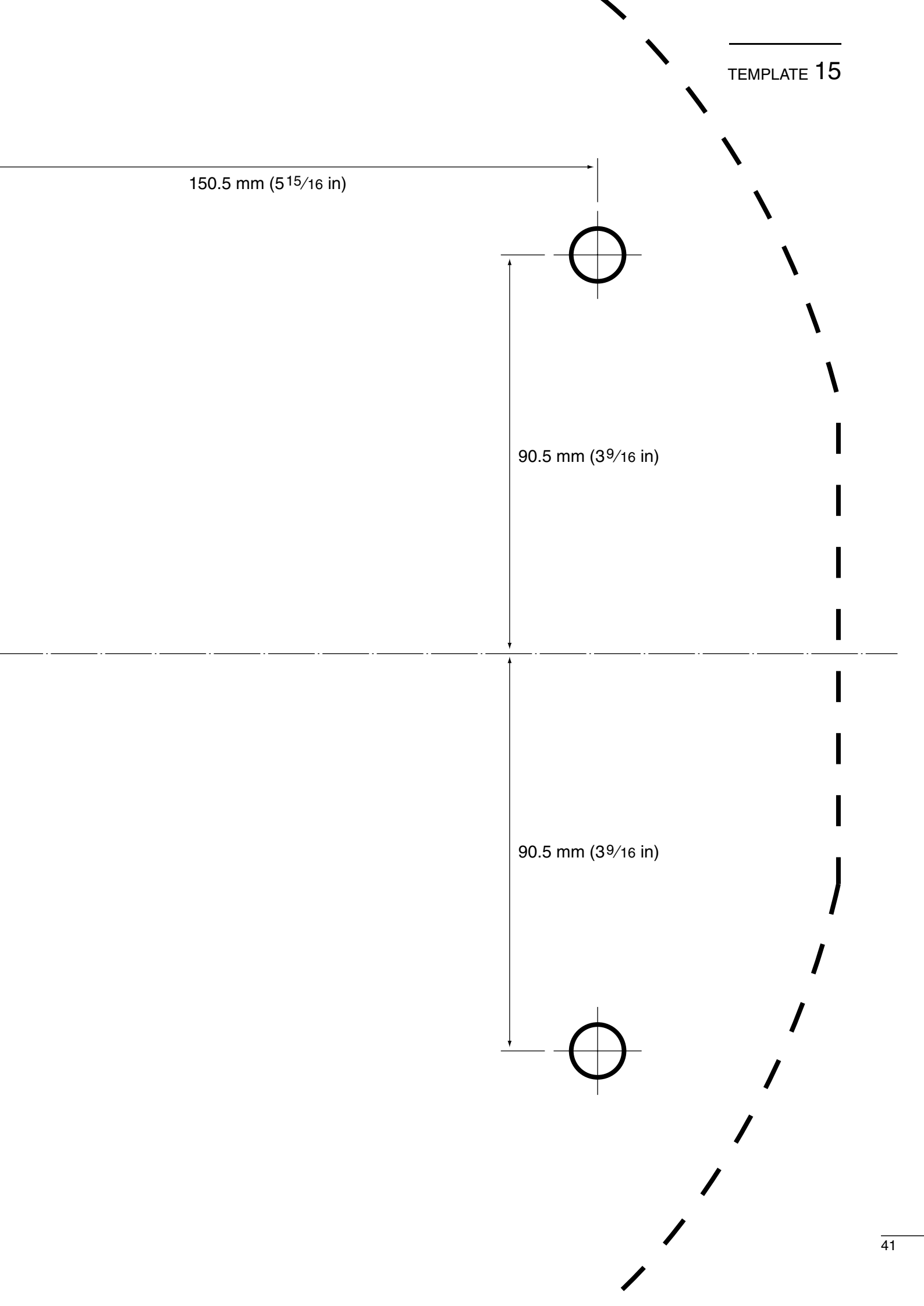



DECLARATION OF CONFORMITY

We Icom Inc. Japan
1-1-32, Kamiminami, Hirano-ku
Osaka 547-0003, Japan

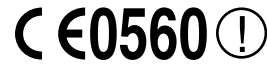

Declare on our sole responsibility that this equipment complies the essential requirements of the Radio and Telecommunications Terminal Equipment Directive, 1999/5/EC, and that any applicable Essential Test Suite measurements have been performed.

Düsseldorf 07 Feb. 2001
Place and date of issue

Kind of equipment: MARINE RADAR

Type-designation: MR-570R

Icom (Europe) GmbH
Himmelgeisterstraße 100
D-40225 Düsseldorf

Authorized representative name

Version (where applicable):

This compliance is based on conformity with the following harmonised standards, specifications or documents:

- i) EN60950 August 1992, A11 1997
- ii) EN60945 1997
- iii) EN61162-1 2000
- iv) Radio Regulation Appendix S3, 1998
- v) _____

Icom (Europe) GmbH

T. Aoki
General Manager

Signature

Icom Inc.



CE Versions of the MR-570R which display the "CE" symbol on the serial number seal, comply with the essential requirements of the European Radio and Telecommunication Terminal Directive 1999/5/EC.



This warning symbol indicates that this equipment operates in non-harmonised frequency bands and/or may be subject to licensing conditions in the country of use. Be sure to check that you have the correct version of this radio or the correct programming of this radio, to comply with national licensing requirement.

Count on us!

<Intended Country of Use>

- | | | |
|------------------------------|------------------------------|------------------------------|
| <input type="checkbox"/> GER | <input type="checkbox"/> NED | <input type="checkbox"/> ITA |
| <input type="checkbox"/> AUT | <input type="checkbox"/> BEL | <input type="checkbox"/> GRE |
| <input type="checkbox"/> GBR | <input type="checkbox"/> LUX | <input type="checkbox"/> SWE |
| <input type="checkbox"/> IRL | <input type="checkbox"/> ESP | <input type="checkbox"/> DEN |
| <input type="checkbox"/> FRA | <input type="checkbox"/> POR | <input type="checkbox"/> FIN |