



INSTRUCTION MANUAL

VHF MOBILE TRANSCEIVERS

IC-F5062

IC-F5062D

UHF MOBILE TRANSCEIVERS

IC-F6062

IC-F6062D



Icom Inc.

IMPORTANT

READ ALL INSTRUCTIONS carefully and completely before using the transceiver.

SAVE THIS INSTRUCTION MANUAL — This instruction manual contains important operating instructions for the **IC-F5062 and IC-F5062D VHF MOBILE TRANSCEIVERS, IC-F6062 and IC-F6062D UHF MOBILE TRANSCEIVERS.**

/// See the operating guide for details of BIIS, MDC, LTR® and Digital system operations. Ask your dealer for details.

EXPLICIT DEFENITIONS

WORD	DEFINITION
 WARNING	Personal injury, fire hazard or electric shock may occur.
CAUTION	Equipment damage may occur.
NOTE	If disregarded, inconvenience only. No risk of personal injury, fire or electric shock.

Icom, Icom Inc. and the Icom logo are registered trademarks of Icom Incorporated (Japan) in Japan, the United States, the United Kingdom, Germany, France, Spain, Russia and/or other countries.

LTR is a registered trademark of the E.F.Johnson Company.

All other products or brands are registered trademarks or trademarks of their respective holders.

PRECAUTIONS

⚠ WARNING! NEVER connect the transceiver to an AC outlet. This may pose a fire hazard or result in an electric shock.

⚠ WARNING! NEVER connect the transceiver to a power source of more than 16 V DC such as a 24 V battery. This connection will ruin the transceiver.

⚠ WARNING! NEVER cut the DC power cable between the DC plug and fuse holder. If an incorrect connection is made after cutting, the transceiver might be damaged.

⚠ WARNING! NEVER place the transceiver where normal operation of the vehicle may be hindered or where it could cause bodily injury.

CAUTION! NEVER allow children to touch the transceiver.

CAUTION! NEVER expose the transceiver to rain, snow or any liquids.

USE the specified microphone only. Other microphones have different pin assignments and may damage the transceiver.

DO NOT use or place the transceiver in areas with temperatures below -25°C or above $+55^{\circ}\text{C}$, or in areas subject to direct sunlight, such as the dashboard.

DO NOT operate the transceiver without running the vehicle's engine. The vehicle's battery will quickly run out when the transceiver transmits while the vehicle's engine is OFF.

DO NOT place the transceiver in excessively dusty environments.

DO NOT place the transceiver against walls. Otherwise heat dissipation will be obstructed.

DO NOT use chemical agents such as benzine or alcohol when cleaning, as they damage the transceiver surfaces.

BE CAREFUL! The transceiver will become hot when operating continuously for long periods.

Icom optional equipment are designed for optimal performance when used with this transceiver. We are not responsible for the transceiver being damaged or any accident caused when using non-Icom optional equipment.

VOICE CODING TECHNOLOGY

The AMBE+2™ voice coding Technology embodied in this product is protected by intellectual property rights including patent rights, copyrights and trade secrets of Digital Voice Systems, Inc. This voice coding Technology is licensed solely for use within this Communications Equipment. The user of this Technology is explicitly prohibited from attempting to extract, remove, decompile, reverse engineer, or disassemble the Object Code, or in any other way convert the Object Code into a human-readable form. U.S. Patent Nos.

#5,870,405, #5,826,222, #5,754,974, #5,701,390, #5,715,365, #5,649,050, #5,630,011, #5,581,656, #5,517,511, #5,491,772, #5,247,579, #5,226,084 and #5,195,166.

TABLE OF CONTENTS

IMPORTANT	i
EXPLICIT DEFENITIONS	i
PRECAUTIONS.....	ii
VOICE CODING TECHNOLOGY	iii
TABLE OF CONTENTS.....	iv
1 PANEL DESCRIPTION.....	1-7
■ Front panel	1
■ Function display	2
■ Programmable function keys	3
2 BASIC OPERATION.....	8-14
■ Turning power ON	8
■ Channel selection.....	8
■ Call procedure.....	9
■ Receiving and transmitting.....	9
■ User set mode.....	12
■ Scrambler function	13
■ Emergency transmission	13
■ Stun function	13
■ Priority A channel selection.....	13
■ Forced Narrow function	14
■ Automatic Key Lock function	14
■ Power Off Emergency function.....	14

3 CONNECTION AND MAINTENANCE	15-19
■ Rear panel connection	15
■ Rear panel connection (Continued).....	16
■ Supplied Accessories.....	17
■ Mounting the transceiver	17
■ Antenna	18
■ Fuse replacement	18
■ Cleaning	18
■ Options.....	19
4 DOC	20

1

2

3

4

1

PANEL DESCRIPTION

■ Front panel

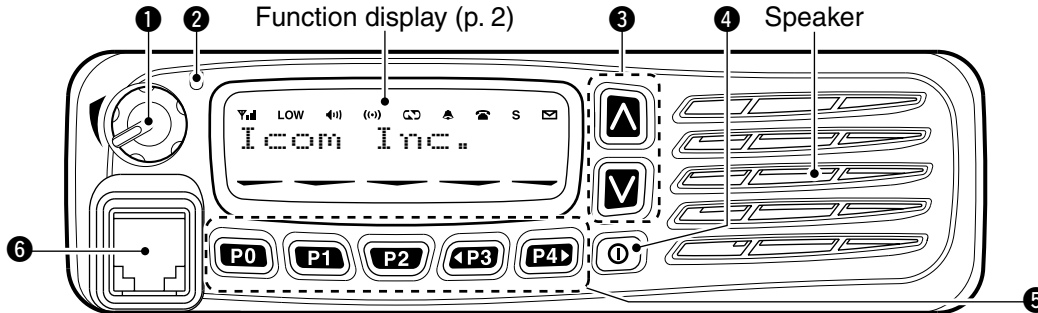

① AF VOLUME CONTROL KNOB [VOL]

- Rotate the knob to adjust the desired audio output level.
- Minimum audio level is pre-programmed.

② LED INDICATOR

- ➔ Lights red while transmitting a signal.
- ➔ Lights green while receiving a signal.

③ UP/DOWN KEYS [CH Up]/[CH Down]

- Push to select an operating channel, etc.
- *The desired function can be assigned by your dealer. (p. 3)

④ POWER SWITCH [Ⓛ]

- Push and hold for 1 sec. to turn the power ON and OFF.
- Automatic scan start, Password prompt and Set mode access are available at power ON.

⑤ DEALER-PROGRAMMABLE KEYS

- Desired functions can be programmed independently by your dealer. (p. 3)

⑥ MICROPHONE CONNECTOR

- Connect the supplied or optional microphone.

⚠ **NEVER** connect non-specified microphones. The pin assignments may be different and the transceiver may be damaged.

◇ MICROPHONE

The supplied microphone has a PTT switch and a hanger hook.

- The following functions are available when the microphone is on or off hook (depending on the setting):
 - Automatic scan starts when it is on hook.
 - Scan is cancelled when it is off hook.
 - Scan is paused when it is off hook.
 - Automatic priority channel selection is available when it is off hook.
 - Sets to 'Inaudible' condition (mute condition) when it is on hook.
 - Sets to 'Audible' condition (unmute condition) when it is off hook.

Function display

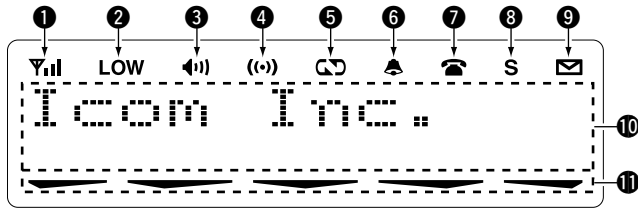

1 SIGNAL STRENGTH INDICATOR

Indicates relative signal strength level as below.



Weak ← Receive Signal level ⇒ Strong

2 LOW POWER INDICATOR

Appears when low output power is selected.

3 AUDIBLE INDICATOR

➔ Appears when the channel is in the 'audible' (unmute) condition.

➔ Appears when the specified 2/5-tone/BIIS*¹/MDC*² code is received.

4 COMPANDER INDICATOR

Appears when the compander function is activated.

5 SCRAMBLER INDICATOR

Appears when the voice scrambler function is activated.

6 BELL INDICATOR

Appears/blinks when the specific 2/5-tone/BIIS*¹/MDC*² code is received, according to the pre-programming.

7 CALL CODE MEMORY INDICATOR

➔ Appears when the call code memory is selected.

➔ Appears when a phone call is received.*³

8 SCROLL INDICATOR

Appears when the SDM, includes more than 12 characters, is selected during the received message selection mode*¹.

9 SDM INDICATOR

Appears when an SDM is received, or an SDM is selected for transmission.*¹

10 ALPHANUMERIC DISPLAY

➔ Displays an operating channel number, channel name, Set mode contents, DTMF code, etc.

➔ The indication mode can be selected from 1 line or 2 lines. Ask your dealer for details.

- In this instruction manual, the LCD illustration is described using the 2 lines indication mode.

11 ACTIVATED KEY INDICATOR

Appears above the key assigned as [Scan A Start/Stop], [Scan B Start/Stop], [Scan Add/Del(Tag)], [Lock], [Talk Around], [Surveillance] and [BIIS button]*¹ keys during that key is activated.

*¹ BIIS operation only

*² MDC operation only

*³ LTR[®] operation only

▨ See the operating guide for details of BIIS, MDC, LTR[®] and Digital system operations. Ask your dealer for details.

1 PANEL DESCRIPTION

■ Programmable function keys

The following functions can be assigned to [UP], [DOWN], [P0], [P1], [P2], [P3] and [P4] programmable function keys. Consult your Icom dealer or system operator for details concerning your transceivers programming.

If the programmable function names are bracketed in the following explanations, the specific key is used to activate the function depends on the programming.

/// **INFORMATION:**

Depending on the pre-setting, the programmed function for [P0], [P1], [P2] or [P3] is assigned to [A], [B], [C] or [D] of the optional HM-152T, respectively. Ask your dealer for details.

CH UP AND DOWN KEYS

- ➔ Push to select an operating channel.
- ➔ Push to select a transmit code channel after pushing [TX Code CH Select].
- ➔ Push to select a DTMF channel after pushing [DTMF Autodial].
- ➔ Push to select a scan group after pushing and holding [Scan A Start/Stop]/[Scan B Start/Stop] for 1 sec.

ZONE KEY

Push this key, then select the desired zone using [CH Up]/[CH Down].

/// **What is “zone”?**—The desired channels are assigned into a zone according to the intended use for grouping. For example, ‘Staff A’ and ‘Staff B’ are assigned into a “Business” zone, and ‘John’ and ‘Cindy’ are assigned into a “Private” zone.

ZONE UP AND DOWN KEYS

Push to select an operating zone.

SCAN KEY

- ➔ Push to start and cancel scanning operation.
 - When Power ON Scan function is activated, push to pause the scanning operation. And the paused scan restarts after the specified time period has passed.
- ➔ Push and hold this key for 1 sec. to indicate the scan list, then push [CH Up] or [CH Down] to select the desired list.

SCAN ADD/DEL (TAG) KEY

- Push to add or delete the selected channel to/from the scan group.
 1. Push to indicate the scan group, then push [CH Up] or [CH Down] to select the desired group.
 2. Push to add or delete the channel to/from the selected scan group.
 3. Push and hold for 1 sec. to exit the scan group selection mode.
- Push this key while scan is paused (a signal is detected) on a channel (except for priority channel,) the channel is cleared from the scan group.
 - ▨ Depending on the setting, the cleared channel is added to the scan group again after the scan is cancelled.

PRIO A/B KEYS

- Push to select Priority A or Priority B channel.
- Push and hold [Prio A (Rewrite)] or [Prio B (Rewrite)] for 1 sec. to rewrite the operating channel as the Priority A or Priority B channel.

MR-CH 1/2/3/4 KEYS

Push to select the memory channel 1 to 4 directly.

MONI (AUDI) KEY

- Push to mute and release the CTCSS (DTCS) or 2-tone squelch mute. Open any squelch/deactivate any mute while pushing and holding this key. (LMR operation only)
 - Activates one of (or two of) the following functions on each channel independently: (PMR operation only)
 - Push and hold to un-mute the channel (audio is emitted; 'Audible' condition).
 - Push to mute the channel (sets to 'Inaudible' only).
 - Push to un-mute the channel (sets to 'Audible' only).
 - Push after the communication is finished to send a 'reset code'. (5-tone/BIS operation only)
- ▨ **NOTE:** The un-mute condition ('Audible' condition) may automatically return to the mute condition ('Inaudible' condition) after a specified period depending on programming.

PUBLIC ADDRESS KEY

Push to activate the Public Address (PA) function for voice amplification. When the PA function is activated, the audio output can be controlled from the transceiver separately with [CH Up]/[CH Down].

- This function is available when the external unit, such as a audio amplifier, speaker, etc. is additionally connected.
- Push this key, then speak into the microphone while pushing and holding [PTT].

1 PANEL DESCRIPTION

RX SPEAKER KEY

Push to turn the RX speaker function ON or OFF.

When the RX speaker function is turned ON, the received audio can be heard via the external speaker.

- This function is available when the external speaker is additionally connected.
- This function is useful when you are out of the vehicle.
- The audio output level is linked to the transceiver's volume control.

LIGHT KEY

Push to turn the transceiver's backlight ON for about 5 sec. when the backlight function is turned OFF in user set mode.

LOCK KEY

Push and hold to electronically lock all programmable keys except the following:

[Moni(Audi)], [Light], [Lock], [Call] (incl. Call A and Call B), [Emergency Single], [Surveillance], [Lone Worker] and [OPT 1/2/3].

LONE WORKER KEY

Push to turn the Lone Worker function ON or OFF.

- If the Lone Worker function is activated, the Emergency function is automatically turned ON after the specified time period has passed with no operation is performed.

HIGH/LOW KEY

Push to select the transmit output power temporarily or permanently, depending on the pre-setting.

- Ask your dealer for the output power level for each selection.

TONE/RAN CH SELECT KEY

➤ While in analog mode operation, push to enter the continuous tone channel selection mode. Then select the desired tone frequency/code setting with [CH Up] or [CH Down]. After the selection, push this key again to set.

➤ While in digital mode operation*, push to enter the RAN channel selection mode. Then select the desired RAN setting with [CH Up] or [CH Down]. After the selection, push this key again to set.

➤ While in mixed (digital and analog) mode operation*, push to enter the continuous tone channel selection mode. Then select the desired tone frequency/code setting with [CH Up] or [CH Down]. After the selection, push this key to set. After that, the RAN channel selection screen appears. Select the desired RAN setting with [CH Up] or [CH Down]. After the selection, push this key again to set.

* Depending on version, digital and mixed (digital and analog) mode operations are available only when the optional UT-126H DIGITAL MODULATOR/DEMODULATOR UNIT is installed. Ask your dealer for details.

C.TONE CH ENT KEY

Push to enter the continuous tone channel selection mode. Then select the desired tone frequency/code setting with [CH Up] or [CH Down]. The selected channel remains set as the continuous tone channel until another channel is designated as such.

TALK AROUND KEY

Push to turn the talk around function ON and OFF.

- The talk around function equalizes the transmit frequency to the receive frequency for transceiver-to-transceiver communication.

WIDE/NARROW KEY

Push to toggle the IF bandwidth between wide and narrow.

- The wide passband width can be selected from 25.0 or 20.0 kHz using the CS-F3160/F5060 CLONING SOFTWARE. (PMR operation only) Ask your dealer for details.

DTMF AUTODIAL KEY

Push to enter the DTMF channel selection mode. Then select the desired DTMF channel using [CH Up]/[CH Down].

After selecting the DTMF channel, push again to transmit the selected DTMF code.

RE-DIAL KEY

Push to transmit the last-transmitted DTMF code.

- TX memories are cleared after turning the transceiver OFF.

CALL KEYS

Push to transmit a 2/5-tone/BIIS ID code.

- Call transmission is necessary before calling another station depending on your signalling system.
- [Call A] and/or [Call B] may be available when your system employs selective 'Individual/Group' calls. Ask your dealer which call is assigned to each key.

EMERGENCY KEY

Push and hold to transmit the emergency call.

- The emergency call transmits with beeps; the display does not change.
- The transceiver can transmit the emergency call silently or with the display changes depending on the pre-setting. Ask your dealer for details.
- If you want to cancel the emergency call, push and hold the key again before transmitting the call.
- The emergency call is transmitted one time only or repeatedly until receiving a control code, depending on the pre-setting.

SURVEILLANCE KEY

Push to turn the surveillance function ON or OFF.

When this function is turned ON, the beep is not emitted and the LCD backlight and the LED indicator do not light when a signal is received or a key is pushed.

TX CODE ENTER KEY (PMR operation only)

Push to enter the ID code edit mode directly, for both 5-tone and MSK. Then set the desired digit using [CH Up]/[CH Down]. (p. 11)

TX CODE CHANNEL SELECT KEY

- Push to enter the ID code channel selection mode directly. Then set the desired channel using [CH Up]/[CH Down]. (p. 10)
- During ID code channel selection mode, push for 1 sec. to enter the ID code edit mode for 5-tone and MSK. Then set the desired digit using [CH Up]/[CH Down]. (p. 11)

1 PANEL DESCRIPTION

TX CODE CHANNEL UP/DOWN KEYS

Push to select a TX code channel directly.

SCRAMBLER/ENCRYPTION KEY

- ➔ While in analog mode operation, push to toggle the voice scrambler function ON and OFF.
- ➔ While in digital mode operation*, push to toggle the encryption transmission function ON and OFF.

* Depending on version, digital mode operation is available only when the optional UT-126H DIGITAL MODULATOR/DEMODULATOR UNIT is installed. Ask your dealer for details.

COMPANDER KEY

Push to toggle the compander function ON and OFF. The compander function reduces noise components from the transmitted audio to provide clear communication.

ID-MR SELECT KEY (PMR operation only)

- ➔ Recalls detected ID codes.
 - Push this key, then select the ID code using [CH Up]/[CH Down].
 - Up to 5 ID's are memorized.
- ➔ Push and hold for 1 sec. to erase the selected ID's.

HOOK SCAN KEY

When the on hook scan function is activated, push this key to disables on hook scan function (stop scanning) temporarily. Push this key again to re-start scanning.

USER SET MODE KEY

- ➔ Push and hold for 1 sec. to enter user set mode.
 - During in the user set mode, push this key to select an item that is enabled by your dealer, and change the value or condition by pushing [CH Up] or [CH Down].
- ➔ Push and hold this key for 1 sec. again to exit user set mode.

User set mode is also available via the 'Power ON function.' Refer to p. 12 also.

10Key ENT KEY

Push to enable the connected microphone's 10-keypad operation.

- The desired memory channel, TX code channel (5-tone), ID list number (digital), TX status (MSK/Digital) or Short Data Message (digital) can be selected. (Depends on the pre-programming.)

OPT 1/2/3 KEYS





Push to control the output signal level from the optional unit connector.

POWER OFF EMERGENCY

While pushing and holding this key, turn the transceiver's power OFF to activate the Power OFF Emergency function. After the specified time period has passed, from the time this function is activated, the emergency call is transmitted with no beep emission and no display indication. (p. 14)

■ Turning power ON

- ① Push and hold [P] for 1 sec. to turn the power ON.
- ② If the transceiver is programmed for a start up password, input the digit codes as directed by your dealer.
 - The keys as below can be used for password input:
The transceiver detects numbers in the same block as identical. Therefore “01234” and “56789” are the same.

KEY					
NUMBER	0	1	2	3	4
	5	6	7	8	9

- ③ When the “PASSWORD” indication does not clear after inputting 6 digits, the input code number may be incorrect. Turn the power off and start over in this case.

■ Channel selection

Several types of channel selections are available. Methods may differ according to your system set up.

NON-ZONE TYPE:

To select the desired operating channel:

- Push [CH Up] or [CH Down].
- Push one of [MR-CH 1] to [MR-CH 4].

ZONE TYPE:

To select the desired zone:

- Push [Zone], then push [CH Up] or [CH Down].
- Push [Zone Up] or [Zone Down].

◇ **Voting operation**

The transceiver automatically starts scanning when a zone, specified for the voting operation, is selected.

The voting scan detects the S-meter of the repeater and automatically selects the strongest station.

AUTOMATIC SCAN TYPE:

Channel setting is not necessary for this type. When turning power ON, the transceiver automatically starts scanning. Scanning stops when receiving a call.

2 BASIC OPERATION

■ Call procedure

When your system employs tone signaling (excluding CTCSS and DTCS), a call procedure may be necessary prior to voice transmission. The tone signalling employed may be a selective calling system which allows you to call specific station(s) only and prevent unwanted stations from contacting you.

- ① Select the desired TX code channel or 2/5-tone code according to your System Operator's instructions.
 - This may not be necessary depending on programming.
 - Refer to pgs. 10–11 for selection.
- ② Push [Call] (assigned to one of the dealer programmable keys).
- ③ After transmitting, the remainder of your communication can be carried out in the normal fashion.

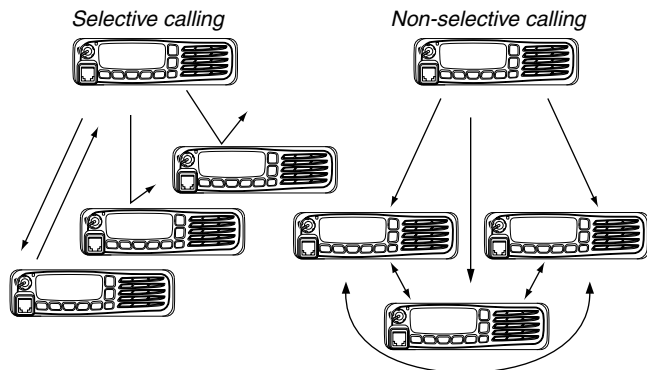

■ Receiving and transmitting

Receiving:

- ① Push and hold [Ⓚ] for 1 sec. to turn the power ON.
- ② Push [CH Up] or [CH Down] to select the conventional system channel, in sequence.
- ③ When receiving a call, rotate [VOL] to adjust the audio output level to a comfortable listening level.

Transmitting:

Wait for the channel to become clear to avoid interference.

- ① Take the microphone off hook.
 - 2/5-tone mute may be released. (The 'audible' condition is selected and BUSY indicator lights green.)
 - A priority channel may be selected automatically.
- ② Wait for the channel to become clear.
 - The channel is busy when BUSY indicator lights green.
- ③ While pushing and holding [PTT], speak into the microphone at your normal voice level.
- ④ Release [PTT] to return to receive.

- IMPORTANT:** To maximize the readability of your signal;
1. Pause briefly after pushing [PTT].
 2. Hold the microphone 5 to 10 cm (2 to 4 inches) from your mouth, then speak into the microphone at a normal voice level.

◇ Transmitting notes

• Transmit inhibit function

The transceiver has several inhibit functions which restrict transmission under the following conditions:

- The channel is in mute condition ('Inaudible' condition; "🔇") (Audible indicator) does not appear.)
- The channel is busy.
- Un-matched (or matched)* CTCSS is received.
*Depending on the pre-setting
- The selected channel is a 'receive only' channel.

• Time-out timer

After continuous transmission for the pre-programmed time period, the time-out timer is activated, causing the transceiver to stop transmitting.

• Penalty timer

Once the time-out timer is activated, transmission is further inhibited for a period determined by the penalty timer.

◇ TX code channel selection

If the transceiver has [TX Code CH Select] assigned to it, the indication can be toggled between the operating channel number (or name) and TX code channel number (or name). When the TX code channel number (or name) is displayed, [CH Up] or [CH Down] selects the TX code channel.

USING [TX CODE CH SELECT] KEY:

- ① Push [TX Code CH Select]— a TX code channel number (or name) appears.
- ② Push [CH Up] or [CH Down] to select the desired TX code channel.
- ③ After selecting, push [TX Code CH Select] to set.
 - Return to the stand-by mode.
- ④ Push [Call] to transmit the selected TX code.

USING [TX CODE CH UP]/[TX CODE CH DOWN] KEY:

If the transceiver has a [TX Code CH Up] or [TX Code CH Down] key assignment, the programmed TX code channel can be selected directly when pushed.

2 BASIC OPERATION

◇ **TX code number edit** (PMR operation only)

If the transceiver has [TX Code CH Select] or [TX Code Enter] assigned to it, TX code contents can be edited within the allowable digits.

USING [TX CODE CH SELECT] KEY:

- ① Push [TX Code CH Select] to enter the TX code channel selection mode.
 - Select the desired channel before entering the TX code channel selection mode if necessary.
- ② Push and hold [TX Code CH Select] for 1 sec. to enter the TX code edit mode.
 - The digit to be edited blinks.
- ③ Push [TX Code CH Select] to select the desired digit to be edited.
- ④ Push [CH Up] or [CH Down] to set the desired digit.
- ⑤ Push [TX Code CH Select] to set. The digit to the right will blink automatically.
- ⑥ Repeat steps ④ and ⑤ to edit all allowable digits.
- ⑦ After editing, push [TX Code CH Select] to set.
 - Return to the stand-by mode.
- ⑧ Push [Call] to transmit.

USING [TX CODE ENTER] KEY:

- ① Push [TX Code Enter] to enter the TX code edit mode.
 - The digit to be edited blinks.
- ② Push [TX Code Enter] to select the desired digit to be edited.
- ③ Push [CH Up] or [CH Down] to select the desired digit.
- ④ Push [TX Code Enter] to set. The digit to the right will blink automatically.
- ⑤ Repeat steps ③ and ④ to input all allowable digits.
- ⑥ After editing, push [TX Code Enter] to set.
 - Return to the stand-by mode.
- ⑦ Push [Call] to transmit.

◇ **DTMF transmission**

If the transceiver has [DTMF Autodial] assigned to it, the automatic DTMF transmission function is available. Up to 8 DTMF channels are available.

- ① Push [DTMF Autodial]— a DTMF channel appears.
- ② Push [CH Up] or [CH Down] to select the desired DTMF channel.
- ③ Push [DTMF Autodial] to transmit the DTMF code.

■ User set mode

User set mode can be accessed with 'Power ON' function. In this case, all set mode items are available.

User set mode allows you to set seldom-changed settings and you can "customize" the transceiver operation to suit your preferences and operating style.

/// **NOTE:** [Up], [Down] and [P0] activate while in the user set mode regardless of the assigned key functions.

Entering the user set mode:

- ① While pushing and holding [P1] and [P2], push [P0] to turn the power ON.
 - Turn power OFF in advance.
 - You should hold [P1] and [P2] until "SET MODE" appears on the display.

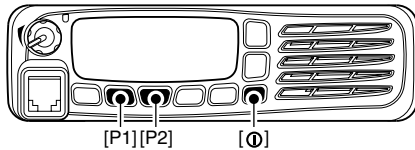

- ② Push and hold [P0] for 1 sec. to enter user set mode.

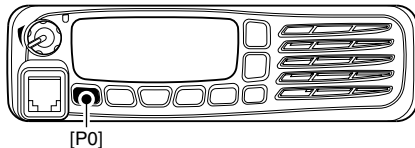

- ③ Push [P0] several times to select the appropriate item. Then, push [Up] or [Down] to set the desired level/condition.

- Available set mode functions are **Backlight**, **LCD Contrast**, **Beep**, **Beep Level**, **Ringer Level**, **SQL Level**, **AF Min Level**, **Mic Gain**, **Battery Voltage**, **Horn**, **Signal Moni**, **Lone Worker** and **System Info**.

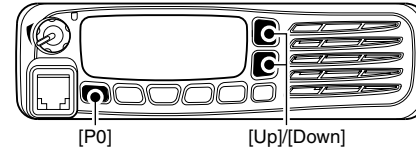

- ④ Push and hold [P0] for 1 sec. to turn power OFF, then ON again to exit set mode.

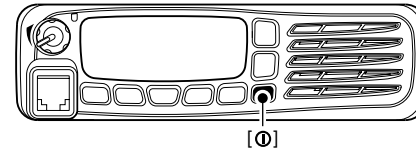



User set mode is also available using a programmable key. Please refer to p. 7 [User Set Mode] section for instructions regarding using the key assigned for user set mode.

[User Set Mode] is allowed for the quick item selection. Set "Enable" for the often used items with the CS-F3160/F5060 CLONING SOFTWARE. Ask your dealer for details.

2 BASIC OPERATION

■ Scrambler function

The voice scrambler function provides private communication between stations. The frequency inversion type is equipped to all versions, moreover, the optional Rolling or Non-rolling type can be available.

- ① Push [Scrambler] to turn the scrambler function ON.
 - “” appears.
- ② Push [Scrambler] again to turn the scrambler function OFF.
 - “” disappears.

■ Emergency transmission

When [Emergency] is pushed for the specified time period, an emergency signal is automatically transmitted. (p. 6)

When [Emergency] is pushed for the specified time period, the DTMF or 5-tone* emergency signal is transmitted once or repeatedly on the emergency channel. However, when no emergency channel is specified, the signal is transmitted on the previously selected channel.

If you want to cancel the emergency call, push and hold the key again before transmitting the call.

* Depending on the operating model type.

■ Stun function

When the specified ID, set as a kill ID, is received, the stun function is activated.

When the kill ID is received, the transceiver switches to the password required condition. Entering of the password (p. 8) is necessary to operate the transceiver again in this case.

■ Priority A channel selection

When one of the following operations is performed, the transceiver selects the Priority A channel automatically.

- Turning the power ON
The Priority A channel is selected each time the transceiver power is turned ON.
- Status call
The Priority A channel is selected when transmitting a status call. (BIS operation only)
- Off hook.
The Priority A channel is selected when the microphone is taken off from its hanger.

■ Forced Narrow function

Depending on the pre-setting, the Forced Narrow function is turned ON or OFF when the transceiver power is ON while pushing and holding both [P1] and [PTT].

While the function is activated, the channel width becomes Narrow regardless of the channel setting, the [Wide/Narrow] key operation, repeater setting, and PC control command.

If the Forced Narrow function is turned ON by your dealer, the channel width becomes Narrow without your operation as above.

■ Automatic Key Lock function

When [Lock] is assigned to any key and the Automatic Key Lock timer is pre-programmed* by your dealer, the key lock function can be automatically turned ON after the specified time period has passed without operation during standby condition.

While the lock function is ON, push and hold [Lock] for 1 sec. to turn the function OFF.

*When "0" is programmed, this function is not available.

■ Power Off Emergency function

If the new function key, [Power OFF Emergency], is assigned to any key, you can use the Power OFF Emergency function.

To activate the Power OFF Emergency function, turn the transceiver's power OFF while pushing and holding [Power OFF Emergency].

After the specified time period has passed, from the time this function is activated, the emergency call is transmitted (with no beep emission and no display indication).

If you want to cancel the emergency call, turn the transceiver's power ON.

And also, depending on the pre-setting, the Remote Monitor function can be used while this function is activated.

■ Rear panel connection

◇ For mobile operation

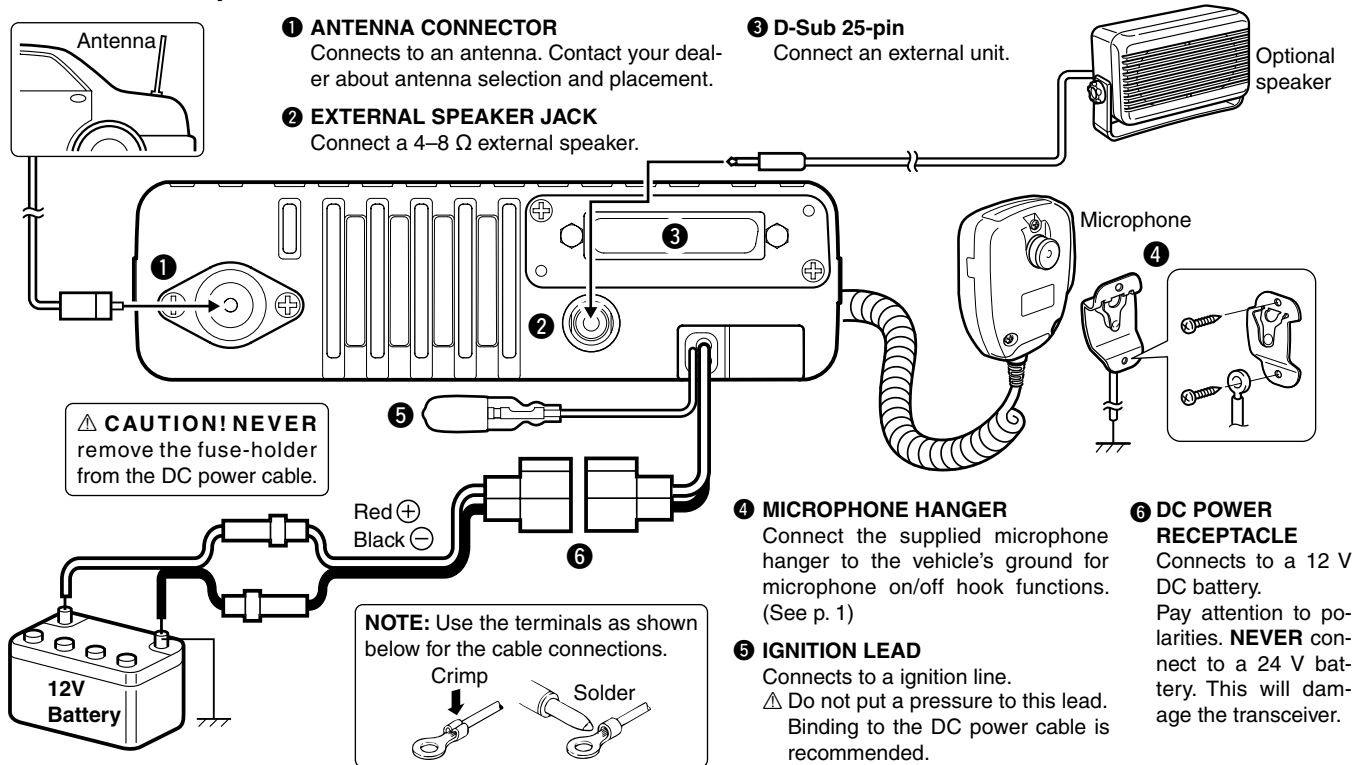





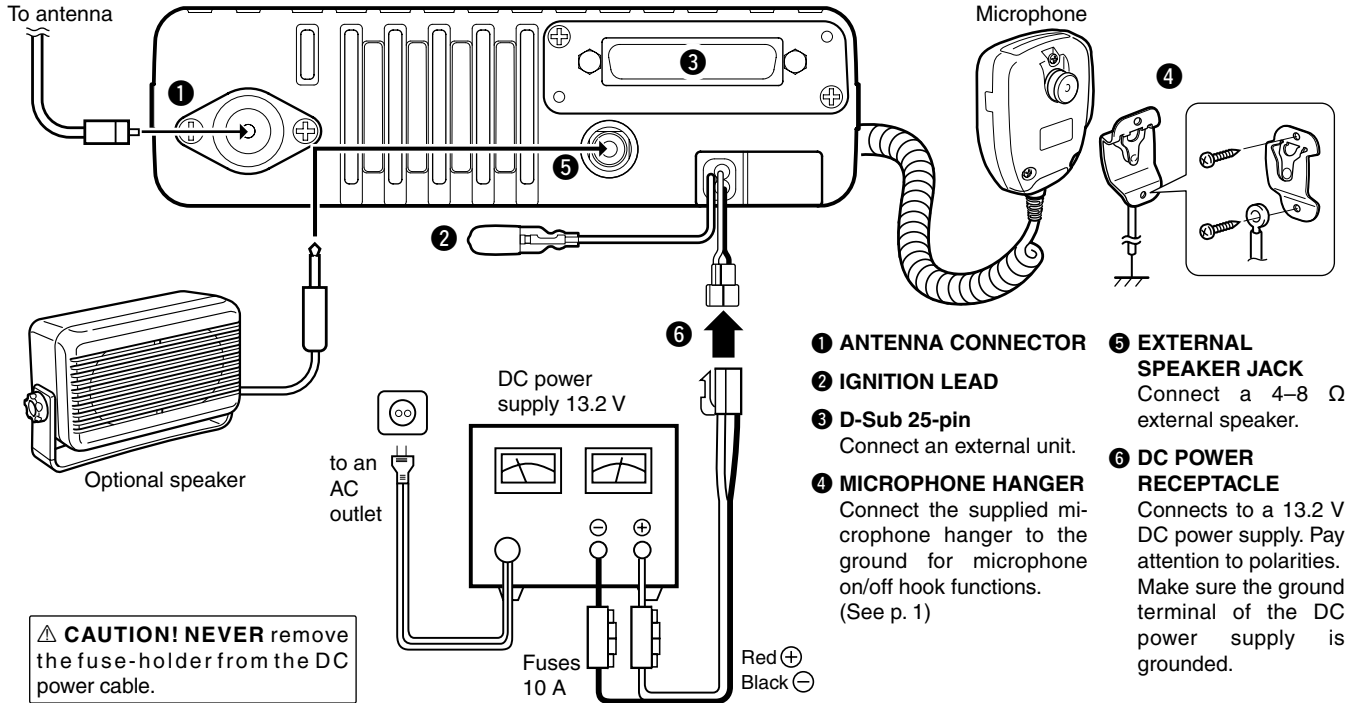



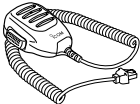

■ Rear panel connection (Continued)

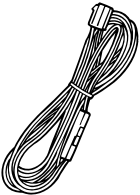
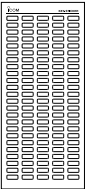
◇ For base station operation

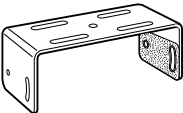

3 CONNECTION AND MAINTENANCE

■ Supplied Accessories

Microphone 	Microphone hanger and screw set 	Microphone hanger cable 
DC power cable 	Function name stickers*1 	Sponges*2 
Mounting bracket 	Flat washers 	Bracket bolts 
	Spring washers 	Mounting screws (M5×12) 
	Nuts 	Self-tapping screws (M5×16) 

*1 Used for labelling the programmable function keys according to their assigned functions.

*2 Used for the optional unit installation. Ask your dealer for details.

■ Mounting the transceiver

The universal mounting bracket supplied with your transceiver allows overhead mounting.

- Mount the transceiver securely with the 4 supplied screws to a thick surface which can support more than 1.5 kg.

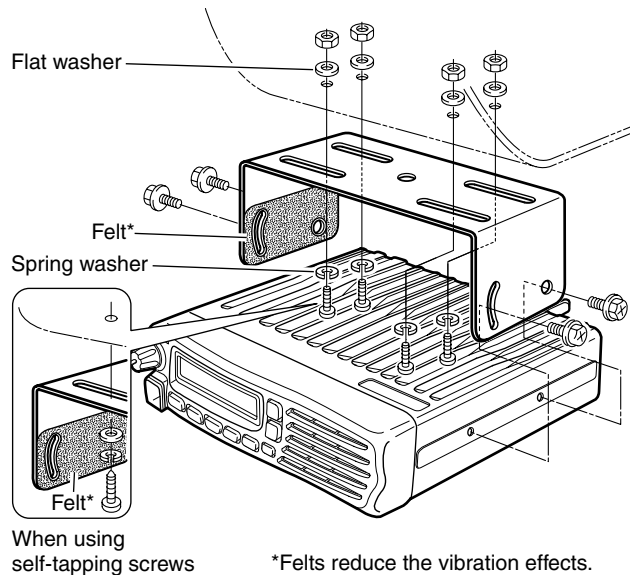

■ Antenna

A key element in the performance of any communication systems is an antenna. Contact your dealer about antennas and the best places to mount them.

■ Fuse replacement

A fuse is installed in each fuse holder of the supplied DC power cable. If a fuse blows or the transceiver stops functioning, track down the source of the problem if possible, and replace the damaged fuse with a new rated one.

□ Fuse rating: 10 A

USE the 10 A fuse only.

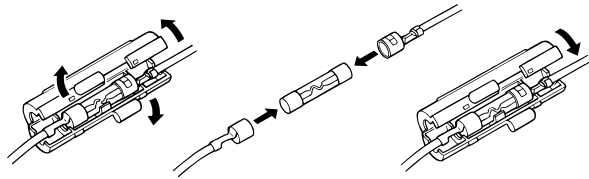

■ Cleaning

If the transceiver becomes dusty or dirty, wipe it clean with a soft and dry cloth.



AVOID the use of solvents such as benzene or alcohol, as they may damage the transceiver surfaces.

3 CONNECTION AND MAINTENANCE

■ Options

- **RMK-3** SEPARATION KIT + **OPC-609** SEPARATION CABLE
Allows you to install the transceiver main unit separately from the front panel for operating convenience.
- **SP-5/SP-10/SP-22** EXTERNAL SPEAKERS
Input impedance : 4 Ω
Max. input power : 5 W
SP-5 : Large speaker for good audio quality.
SP-10 : For all-round mobile operation.
SP-22 : Compact and easy-to-install.
- **HM-152/HM-152T/HM-148G/HM-148T** HAND MICROPHONES
HM-152 : Hand microphone
HM-152T : DTMF microphone
HM-148G: Self grounding heavy duty microphone
HM-148T : Self grounding heavy duty microphone with 10-keypad
The 10-keypad of this microphone can be used for the DTMF code transmission only.
- **SM-25** DESKTOP MICROPHONE

- **UT-109R/UT-110R** SCRAMBLER UNITS
Non-rolling type (UT-109R)/Rolling type (UT-110R) voice scrambler unit provides higher communication security.
- **UT-126H** DIGITAL MODULATOR/DEMODULATOR UNIT
Provides 6.25 kHz digital mode operation.
(UT-126H is a upgrade version of UT-119H. UT-119H can be used depending on the version. Ask your dealer for details.)

Some options may not available in some countries. Ask your dealer for details.



We Icom Inc. Japan
1-1-32, Kamiminami, Hirano-ku
Osaka 547-0003, Japan

Declare on our sole responsibility that this equipment complies with the essential requirements of the Radio and Telecommunications Terminal Equipment Directive, 1999/5/EC, and that any applicable Essential Test Suite measurements have been performed.

Kind of equipment: VHF TRANSCEIVER

Type-designation: IC-F5062

136-174 MHz 12.5 KHz/25 KHz
136-174 MHz 12.5 KHz/20 KHz
136-174 MHz 6.25 KHz

Version (where applicable):

This compliance is based on conformity with the following harmonised standards, specifications or documents:

- i) EN 60950-1 2001
- ii) EN 301 489-1 v1.4.1 (August 2002)
- iii) EN 301 489-5 v1.3.1 (August 2002)
- iv) EN 300 086-2 v1.1.1 (March 2001)
- v) EN 300 219-2 v1.1.1 (March 2001)
- vi) EN 300 113-2 v1.3.1 (December 2003)
- vii) EN 301 166-2 v1.1.1 (December 2001)

DECLARATION OF CONFORMITY

CE0168

Düsseldorf 15th Feb. 2008
Place and date of issue

Icom (Europe) GmbH
Himmelgeisterstraße 100
D-40225 Düsseldorf

Authorized representative name

Y. Furukawa
General Manager

Signature



Icom Inc.



CE Versions of the IC-F5062/IC-F5062D and IC-F6062/IC-F6062D which display the “CE” symbol on the serial number seal, comply with the essential requirements of the European Radio and Telecommunication Terminal Directive 1999/5/EC.



This warning symbol indicates that this equipment operates in non-harmonised frequency bands and/or may be subject to licensing conditions in the country of use. Be sure to check that you have the correct version of this radio or the correct programming of this radio, to comply with national licensing requirement.

	DECLARATION OF CONFORMITY
<p>We Icom Inc. Japan 1-1-32, Kamiminami, Hirano-ku Osaka 547-0003, Japan</p>	
<p>Declare on our sole responsibility that this equipment complies with the essential requirements of the Radio and Telecommunications Terminal Equipment Directive, 1999/5/EC, and that any applicable Essential Test Suite measurements have been performed.</p>	<p><u>Düsseldorf 15th Feb. 2008</u> Place and date of issue</p>
<p>Kind of equipment: <u>UHF TRANSCEIVER</u></p>	<p>Icom (Europe) GmbH Himmelgeister straÙe 100 D-40225 Düsseldorf</p>
<p>Type-designation: <u>IC-F6062</u></p>	<p>Authorized representative name</p>
<p>Version (where applicable):</p>	<p>Y. Furukawa General Manager</p>
<p>This compliance is based on conformity with the following harmonised standards, specifications or documents:</p>	
<p>i) <u>EN 60950-1 2001</u> ii) <u>EN 301 489-1 v1.4.1 (August 2002)</u> iii) <u>EN 301 489-5 v1.3.1 (August 2002)</u> iv) <u>EN 300 086-2 v1.1.1 (March 2001)</u> v) <u>EN 300 219-2 v1.1.1 (March 2001)</u> vi) <u>EN 300 113-2 v1.3.1 (December 2003)</u> vii) <u>EN 301 166-2 v1.1.1 (December 2001)</u></p>	
<p>Signature</p>	<p>Icom Inc.</p>

About e-marking: Detailed installation notes for Icom mobile transceivers to be fitted into vehicles are available. Please contact your Icom dealer or distributor.

Count on us!

< Intended Country of Use >

- GER FRA ESP SWE
 AUT NED POR DEN
 GBR BEL ITA FIN
 IRL LUX GRE SUI
 NOR

A-6566D-1EU-③
Printed in Japan
© 2007–2009 Icom Inc.

Printed on recycled paper with soy ink.

Icom Inc.

1-1-32 Kamiminami, Hirano-ku, Osaka 547-0003, Japan