

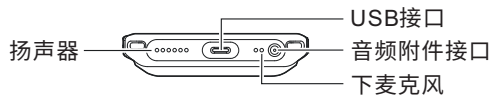

PNC560 5G专业安全终端
PNC560 5G XSecure Rugged Device

快速操作手册
QUICK REFERENCE GUIDE

熟悉产品

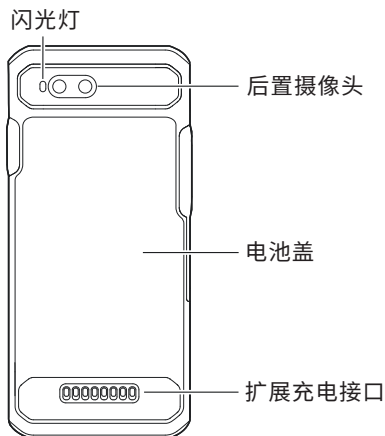
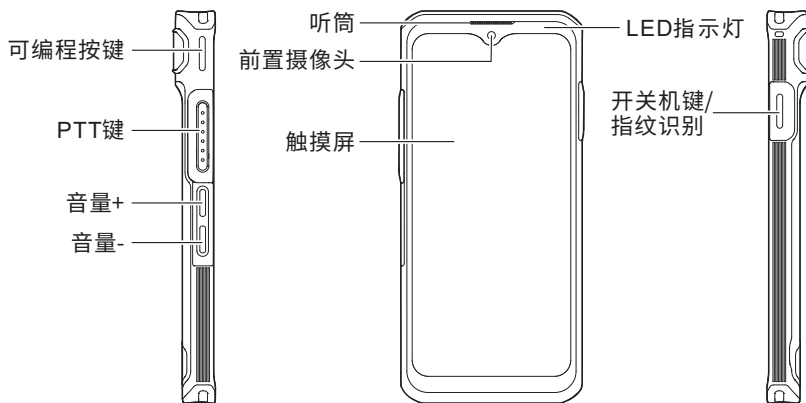
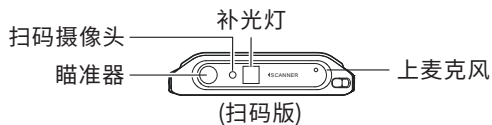
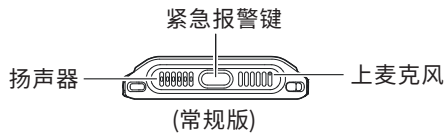

用前准备

插卡

1. 按照图示从扣手位拆卸电池盖。
2. 按照图示将Nano SIM卡和Micro SD卡插入对应的卡槽,注意缺口方向。

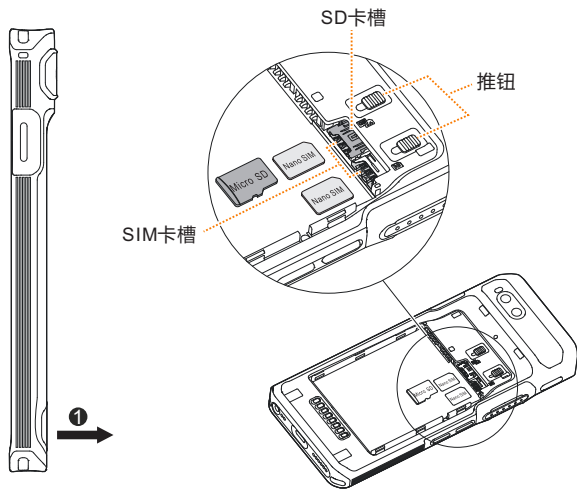

备注

取出Nano SIM卡前,请先滑动推钮至Nano SIM卡弹出。

安装电池

注意

- 为避免更换电池发生爆炸危险,请使用我司指定型号的电池。
- 请务必按照《安全信息手册》之“回收处理安全注意事项”处置用完的电池。
- 若终端在使用中需更换电池,请在关机后再更换电池,以免用户数据丢失。

安装电池前,请先取下电池盖,将电池的触点对准主机上的触点,按照图示安装电池。完成安装后,装回电池盖。

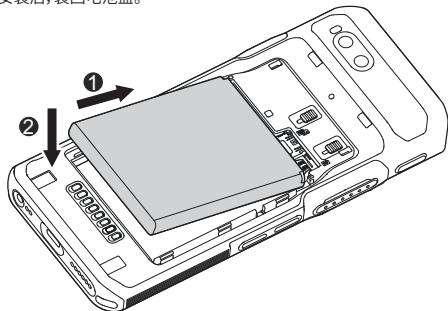

充电

注意

- 请使用我司指定的充电设备充电。
- 请在充电前参阅《安全信息手册》之“严禁充电”,以获取必要的电池安全信息。
- 根据国际民航(IATA)《危险物品安全航空运输技术细则》规定要求,航空运输的锂离子电池(芯)的荷电状态不得超过其额定容量的30%。因此,电池配主机首次使用可能会出现低电告警现象,请在使用前先对电池进行充电。

使用数据线插入USB接口,连接电源适配器、移动电源或PC,可以对电池进行充电。充电过程中,观察触摸屏的电池电量图标或电量百分比,可以查看电池电量是否已充满。

开始使用

开机/关机

- 关机后,长按【开机机】键,直至屏幕显示开机画面。
- 开机后,长按【开机机】键,选择“关机”。

熄屏/亮屏

- 短按【开机机】键锁定屏幕进入熄屏状态。
- 屏幕熄灭时,短按【开机机】键点亮屏幕。

连接WLAN

本产品可以通过WLAN (Wireless Local Area Networks, 无线局域网)连接到互联网。

1. 点击“设置 > 网络和互联网 > WLAN”,开启WLAN开关。
2. 从检测到的无线局域网列表中选择可用的网络进行连接。

如果网络是加密的,请输入网络密码,然后选择连接。

如需了解更多,请访问<https://www.hytera.com/cn/download-center.html>或扫描二维码,在线查看或下载配套的说明书。



Product Layout

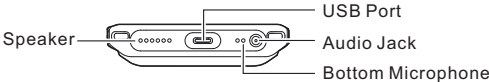
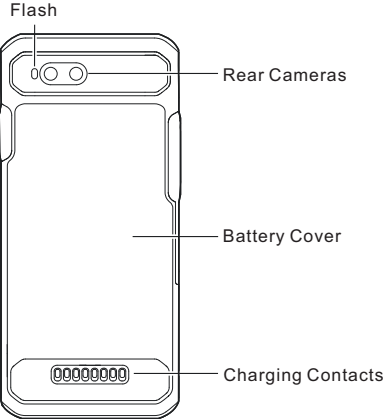
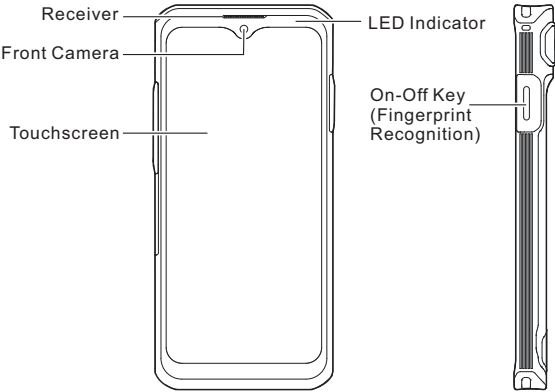
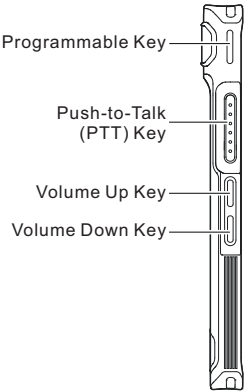
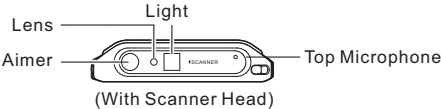
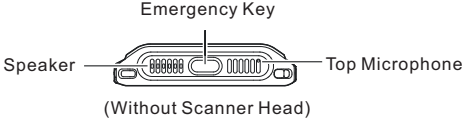

Before Use

Installing the Cards

1. Remove the battery cover.
2. Insert the Nano SIM card and the Micro SD card into the corresponding slots with the metal contacts facing down.

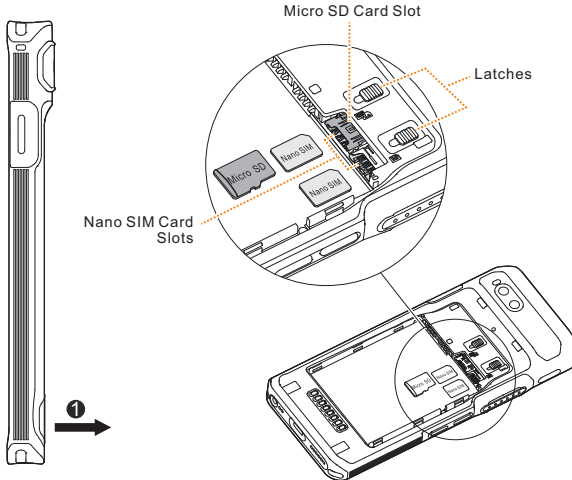

NOTE

To remove the Nano SIM card, slide the latch to eject the corresponding card.

Attaching the Battery

CAUTION

- Use the approved battery to avoid the risk of explosion.
 - Dispose of the used battery according to "Precautions for Disposal" in the *Safety Information Booklet*.
 - Turn off the device before replacing the battery to avoid data loss.
1. Remove the battery cover.
 2. Align the contacts on the battery with those on the battery slot, and then slide the battery into the slot.
 3. Put the battery cover back in place.

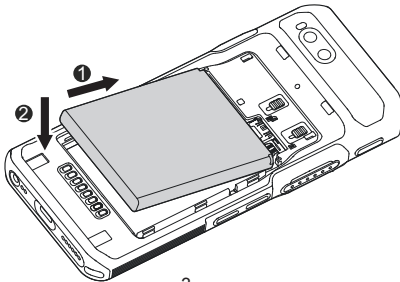

Charging the Battery

CAUTION

- Use the approved charger to charge the battery.
- Read the *Safety Information Booklet* before charging.
- The remaining lithium-ion battery power is limited to 30% pursuant to the new lithium battery shipment regulation approved by the International Air Transport Association (IATA).

Connect the product to the power adapter, power bank, or PC through the USB data cable.

During charging, check the charging status through the battery icon or percentage on the touchscreen.

Basic Operations

Turning On the Product

Long press the **On-Off** key until the startup screen appears.

Turning Off the Product

Long press the **On-Off** key, and then select **Power off**.

Turning the Touchscreen On or Off

Short press the **On-Off** key.

Connecting to the WLAN

1. Go to **Settings > Network & internet > WLAN**.
2. Enable **Use WLAN**.
3. Select an available network from the WLAN list.
4. (Optional) If a password is required, enter the password, and then tap **CONNECT**.

For details, please visit our website at: <https://www.hytera.com/en/download-center.html>, or scan the QR code to download the relevant *User Manual*.



Hytera 

is the trademark or registered trademark of Hytera Communications Corporation Limited.

©2022 Hytera Communications Corporation Limited. All Rights Reserved.

Address: Hytera Tower, Hi-Tech Industrial Park North, 9108# Beihuan Road, Nanshan District, Shenzhen, People's Republic of China

Postcode: 518057

[https:// www.hytera.com](https://www.hytera.com)

Hytera 

是海能达通信股份有限公司的注册商标或商标

©2022 海能达通信股份有限公司。版权所有

地址：深圳市南山区高新区北区北环路9108号海能达大厦

邮编：518057

服务热线：400-830-7020

[https:// www.hytera.com](https://www.hytera.com)



5202010081218B