



*USER MANUAL*

***MD78X(G)/MD78Xi(G) DIGITAL MOBILE RADIO***





Welcome to the world of Hytera and thank you for purchasing this product. This manual includes a description of the functions and step-by-step procedures for use. It also includes a troubleshooting guide. To avoid bodily injury or property loss caused by incorrect operation, please carefully read the *Safety Information Booklet* before use.

This manual is applicable to the following product:

MD78X(G)/MD78Xi(G) Digital Mobile Radio (X may represent 2, 5, 6, or 8)

## Copyright Information

Hytera is the trademark or registered trademark of Hytera Communications Corporation Limited (the Company) in the People's Republic of China (PRC) and/or other countries or areas. The Company retains the ownership of its trademarks and product names. All other trademarks and/or product names that may be used in this manual are properties of their respective owners.

The product described in this manual may include the Company's computer programs stored in memory or other media. Laws in PRC and/or other countries or areas protect the exclusive rights of the Company with respect to its computer programs. The purchase of this product shall not be deemed to grant, either directly or by implication, any rights to the purchaser regarding the Company's computer programs. The Company's computer programs may not be copied, modified, distributed, decompiled, or reverse-engineered in any manner without the prior written consent of the Company.

## Disclaimer

The Company endeavors to achieve the accuracy and completeness of this manual, but no warranty of accuracy or reliability is given. All the specifications and designs are subject to change without notice due to continuous technological development. No part of this manual may be copied, modified, translated, or distributed in any manner without the prior written consent of the Company.

We do not guarantee, for any particular purpose, the accuracy, validity, timeliness, legitimacy or completeness of the third-party products and contents involved in this manual.

If you have any suggestions or would like to receive more information, please visit our website at <http://www.hytera.com>.

## RF Radiation Information

This product must be restricted to operations in an Occupational/Controlled RF exposure Environments. Users must be fully aware of the hazards of the exposure and able to exercise control over their RF exposure to qualify for the higher exposure limits.

### RF Radiation Profile

Radio Frequency (RF) is a frequency of electromagnetic radiation in the range at which radio signals are transmitted. RF technology is widely used in communication, medicine, food processing and other fields. It may generate radiation during use.

### RF Radiation Safety

In order to ensure user health, experts from relevant industries including science, engineering, medicine and health work with international organizations to develop standards for safe exposure to RF radiation. These standards consist of:

- United States Federal Communications Commission, Code of Federal Regulations; 47 CFR § 1.1307, 1.1310 and 2.1091
- American National Standards Institute (ANSI) / Institute of Electrical and Electronic Engineers (IEEE) C95.1:2005; Canada RSS102 Issue 5 March 2015
- Institute of Electrical and Electronic Engineers (IEEE) C95.1:2005 Edition

## FCC Statement

This equipment has been tested and found to comply with the limits for a Class B digital device, pursuant to part 15 of FCC Rules. These limits are designed to provide reasonable protection against harmful interference in a residential installation. This equipment generates and can radiate radio frequency energy. If not installed and used in accordance with the instructions, it may cause harmful interference to radio communications. However, there is no guarantee that interference will not occur in a particular installation. Verification of harmful interference by this equipment to radio or television reception can be determined by turning it off and then on. The user is encouraged to try to correct the interference by one or more of the following measures:

- Reorient or relocate the receiving antenna. Increase the separation between the equipment and receiver.
- Connect the equipment into an outlet on a different circuit to that of the receiver's outlet.
- Consult the dealer or an experienced radio/TV technician for help.

Operation is subject to the following two conditions:

- This device may not cause harmful interference.
- This device must accept any interference received, including interference that may cause undesired operation.

Note: Changes or modifications to this unit not expressly approved by the party responsible for compliance could void the user's authority to operate the equipment.

## FCC Regulations

Federal Communication Commission (FCC) requires that all radio communication products should meet the requirements set forth in the above standards before they can be marketed in the U.S, and the manufacturer shall post a RF label on the product to inform users of operational instructions, so as to enhance their occupational health against exposure to RF energy.

## **Operational Instructions and Training Guidelines**

To ensure optimal performance and compliance with the occupational/controlled environment RF energy exposure limits in the above standards and guidelines, users should always adhere to the followings:

- Gain of antenna must not exceed 5dBi (UHF) or 3.5dBi (VHF).
- Antenna Installation: install the antenna at least 100cm away from your body, in accordance with the requirements of the antenna manufacturer/supplier.

## **EU Regulatory Conformance**

As certified by the qualified laboratory, the product is in compliance with the essential requirements and other relevant provisions of 2014/53/EU, 2012/19/EU, and 2011/65/EU.

Please note that the above information is applicable to EU countries only.

# Contents



---

<b>Contents</b> .....	1	Group Call .....	8
<b>Documentation Information</b> .....	3	Private Call .....	9
<b>Packing List</b> .....	3	All Call .....	10
Conventional/Trunking Radio .....	3	Broadcast Call (Trunking Only) .....	11
Duplex Radio .....	3	Include Call (Trunking Only) .....	12
<b>Product Overview</b> .....	4	Phone Call .....	12
Product Layout .....	4	Call on Analog Channel (Conventional Only) .....	13
Programmable Keys .....	4	<b>Message Services</b> .....	<b>13</b>
<b>Installation</b> .....	<b>5</b>	Viewing a Message .....	13
Instructions .....	5	Sending a Message .....	13
Tools .....	5	Deleting a Message .....	14
Parts .....	5	<b>General Features</b> .....	<b>14</b>
Procedure .....	5	Radio Settings .....	15
<b>Basic Operations</b> .....	<b>6</b>	Audio Settings .....	17
Turning the Radio On or Off .....	6	One Touch Call/Menu .....	18
Adjusting the Volume .....	6	Scan .....	18
Using the Keypad .....	6	Hunt .....	19
Switching the Operation Mode .....	6	Contact Management .....	19
<b>Status Indications</b> .....	<b>7</b>	TOT .....	20
Checking LCD Icons .....	7	Busy Channel Lockout .....	20
Checking LED Indications .....	8	Customized Single Tone .....	20
<b>Call Services</b> .....	<b>8</b>	Priority Interrupt .....	20

Pseudo Trunk .....	21
XPT System .....	21
SRF .....	21
Dual-slot Data Transmission .....	21
Roam .....	21
Clarity Transmission .....	22
Work Order .....	22
Data Inquiry .....	22
Call Divert .....	22
Call Priority .....	22
DGNA .....	22
Position .....	23
Ignition Sense .....	24
Public Address .....	24
Personal Safety Services .....	24
Communication Security Services .....	25
Supplementary Features .....	27
<b>Troubleshooting .....</b>	<b>28</b>
<b>Care and Cleaning .....</b>	<b>30</b>
Product Care .....	30
Product Cleaning .....	30
<b>Optional Accessories .....</b>	<b>30</b>
<b>Abbreviations .....</b>	<b>30</b>

## Documentation Information

### Icon Conventions

Icon	Description
 NOTE	Indicates references that can further describe the related topics.
 CAUTION	Indicates situations that could cause data loss or equipment damage.

### Notation Conventions

Item	Description	Example
<b>Boldface</b>	Denotes menus, tabs, parameter names, window names, dialog names, and hardware buttons.	To save the configuration, click <b>Apply</b> .
		The <b>Log Level Settings</b> dialogue appears.
		Press the <b>PTT</b> key.
"	Denotes messages, directories, file names, folder names, and parameter values.	The screen displays "Invalid Battery!". Open "PDT_PSS.exe". Go to "D:/opt/local". In the <b>Port</b> text box, enter "22".
>	Directs you to access a multi-level menu.	Go to <b>File &gt; New</b> .

Item	Description	Example
<i>Italic</i>	Denotes document titles.	For details about using the DWS, refer to <i>Dispatch Workstation User Guide</i> .
Courier New	Denotes commands and their execution results.	To set the IP address, run the following command: <code>vos-cmd - m name IP</code>

### Packing List

Please unpack carefully and check that you have received the following items. If any item is missing or damaged, please contact your dealer.

### Conventional/Trunking Radio

Item	Quantity (PCS)	Item	Quantity (PCS)
Mobile Radio	1	Locking Knob	2
Mounting Bracket	1	Microphone Hanger	1
Palm Microphone without Keypad (conventional)/with Keypad (trunking)	1	Screw (4 mm x 16 mm)	3
Screw (4.8 mm x 20 mm)	4	Power Cord (with fuse)	1
Documentation Kit	1	/	/

### Duplex Radio

Item	Quantity (PCS)	Item	Quantity (PCS)
Mobile Radio	1	Locking Knob	2
Mounting Bracket	1	Handset Hanger	1
Handset	1	Screw (4 mm x 16 mm)	4
Screw (4.8 mm x 20 mm)	4	Power Cord (with fuse)	1
Documentation Kit	1	/	/

#### NOTE

- Check whether the frequency band marked on the antenna label matches that on the radio label. If not, contact your dealer.
- Figures in this manual are for reference only.

## Product Overview

### Product Layout

#### Front Panel

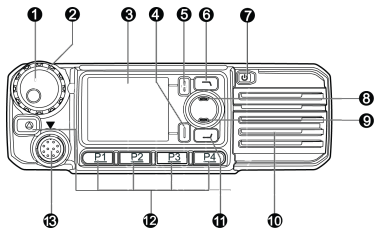

No.	Part Name	No.	Part Name
1	Volume Control & Channel/Group Selector Knob	8	Up Key
2	LED Indicator	9	Down Key
3	LCD Display	10	Speaker
4	OK/Menu Key	11	P5/Answer Key
5	Back/Subgroup Key	12	Programmable Keys
6	P6/End Key	13	Aviation Port
7	On-Off Key	/	/

#### Rear Panel

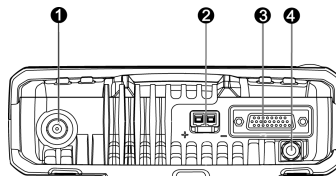

No.	Part Name	No.	Part Name
1	RF Antenna Connector	3	Accessory Connector
2	Power Inlet	4	GPS Antenna Connector

#### NOTE

The GPS antenna connector is used only by radios with the GPS feature.

#### Palm Microphone

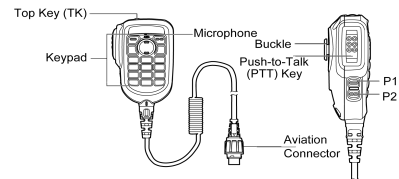
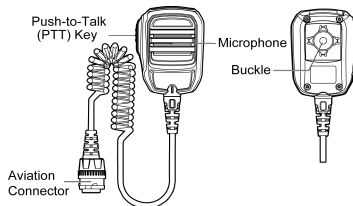

#### NOTE

The palm microphone without keypad is available for the digital radio and the one with keypad is for the trunking radio.

#### Handset

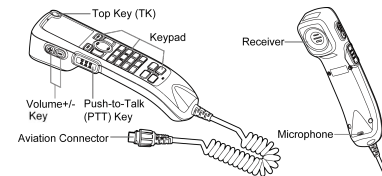

#### NOTE

The handset is available only for the duplex radio.

### Programmable Keys

You can request your dealer to program the following keys as shortcuts to assignable radio features:



- Mobile radio: **P1** key, **P2** key, **P3** key, **P4** key, **TK**, **P5/Answer** key, **P6/End** key, **Up** key, and **Down** key.
- Palm microphone with keypad: **TK**, **P1** key, and **P2** key.
- Handset: Same as the mobile radio.

## Installation

### Instructions

Before installing the radio in a vehicle, read the following instructions carefully:

- The radio must work with a 13.6±15% V negative ground electrical system only. Ensure to check the polarity and voltage of the vehicle power supply.
- Check how long the screws will extend from the bottom surface of the radio. Drill the mounting hole cautiously to avoid damage to the vehicle wiring and other parts.
- Connect the antenna and the power cord to the radio before you install the radio in the bracket. Use the antenna and power cord authorized by the Company only.
- Install the radio with the mounting bracket supplied by the Company to avoid radio looseness in case of accidents. The loose radio may cause bodily injury.
- Install the radio in a location where you can reach the front panel conveniently.
- Keep sufficient clearance at the back of the radio for wiring.
- Be sure to use the fuse with the same specification for the DC power cord upon replacement.
- Ensure that the antenna of the radio must be no less than 10 meters away from that of other RF devices.

### Tools

- Electric drill
- Phillips screwdriver
- T20 torx screwdriver

### Parts

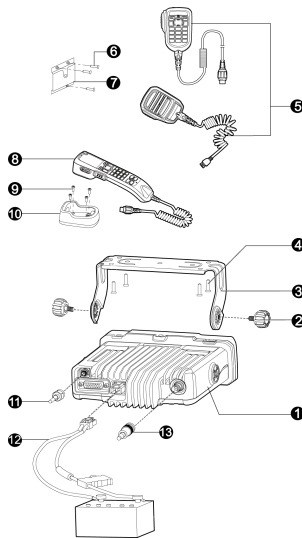

NO.	Part Name	NO.	Part Name
1	Mobile Radio	8	Handset
2	Locking Knob	9	Screw (4 mm x 16 mm)

NO.	Part Name	NO.	Part Name
3	Mounting Bracket	10	Handset Hanger
4	Screw (4.8 mm x 20 mm)	11	GPS Antenna
5	Palm Microphone	12	Power Cord (with fuse)
6	Screw (4 mm x 16 mm)	13	RF Antenna
7	Microphone Hanger	/	/

### NOTE

- The RF antenna should be purchased separately.
- The GPS antenna is available only for radios with the GPS feature.
- The palm microphone without keypad (with ⑥ and ⑦) is available for the digital radio and the one with keypad (with ⑥ and ⑦) is for the trunking radio. The handset (with ⑨ and ⑩) is for the duplex radio.

### Procedure

1. Select a location, drill holes based on the shape of the mounting bracket, and then use the screws (4.8 mm x 20 mm) to secure the bracket.
2. Connect the RF antenna, GPS antenna, and power cord to the radio.
3. Slide the radio into the mounted bracket and secure it using the locking knobs.
4. Install the microphone hanger in a location where you can reach it easily, and use the screws (4 mm x 16 mm) to secure it.
5. Align the triangle index on the palm microphone or the handset with the installation index, plug the

connector into the radio, and rotate the connector clockwise to secure it.

- Place the palm microphone or the handset on the hanger when you do not use it.

## Basic Operations

### Turning the Radio On or Off

To turn the radio on, long press the **On-Off** key.

To turn the radio off, press the **On-Off** key.

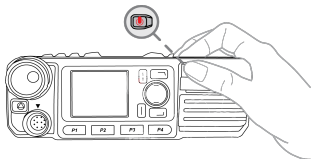

### Adjusting the Volume

- Press the **Volume Control** knob to switch to volume control mode.

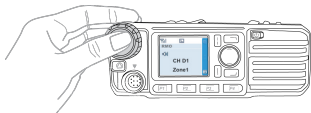

- Rotate the **Volume Control** knob to adjust the volume.



### Using the Keypad

You can use the keypad on the palm microphone or the handset to enter contact aliases or IDs and edit messages.

- To switch the input method between alphabetic mode and numeric mode, press **[A/B]**.
- To enter special characters, press **[1-0]** in alphabetic mode or **[\*#]** in numeric mode.
- To enter a space, press **[Space]** in alphabetic mode.

### Switching the Operation Mode

The radio can operate in conventional or trunking mode. In conventional mode, you can receive and transmit voice and data after selecting the required channel. In trunking mode, you can receive and transmit voice and data after the radio registers with the base station (BS) successfully.

- To manually switch the operation mode, go to **Menu > Mode > Manual Switch**, or press the preprogrammed **Mode Manual Switch** key.
- To allow the radio to automatically switch to conventional mode when the signal drops below the preset level in trunking mode, go to **Menu > Mode > Auto Switch**, or press the preprogrammed **Mode Auto Switch** key.

### Conventional Mode

In conventional mode, the radio receives and transmits data and voice on the selected channel.

### Selecting Zones and Channels

A channel is used to receive and transmit data and voice. A zone is a group of channels within the same operational area. The radio supports up to 64 zones, each of which contains up to 256 channels.

To receive and transmit data and voice, do as follows:

- Select a zone in either of the following ways:
  - On the Zone menu, press the **Up** or **Down** key to select a zone, and then press the **OK/Menu** key.
  - Press the preprogrammed **Zone Up** or **Zone Down** key.
- Select a channel in one of the following ways:
  - Rotate the **Channel Selector** knob.
  - Press the preprogrammed **Channel Up** or **Channel Down** key.
  - Press the preprogrammed **Preset Channel** key.

#### NOTE

If the Voice Notify feature is enabled by your dealer, the radio announces the channel number upon power-on or channel switching.

### Trunking Mode

In trunking mode, the radio communicates with each other through base stations after successful registration. The radio can communicate with a group of radios or a single radio.

### Selecting Subgroups

A subgroup is a group of group or private contacts. To select a subgroup, do either of the following:

- Press the **Back/Subgroup** key, and then press the **Up** or **Down** key.
- Press the preprogrammed **Subgroup Up** or **Subgroup Down** key.

### Selecting Group or Private Contacts

- Rotate the **Group Selector** knob.

- Press the **Back/Subgroup** key, and then press the **Up** or **Down** key to select from the member list.
- Press the preprogrammed **Group/Private Up** or **Group/Private Down** key.



## Status Indications















### Checking LCD Icons







#### Operation Mode

Icon	Radio Status
<b>DM</b>	Direct mode: The radio transmits and receives directly.
<b>RM</b>	Repeater mode: The radio transmits and receives through a repeater.
<b>TM-DW</b>	Trunking Mode - Digital Wide: The radio operates under multiple interconnected BSs.
<b>TM-DL</b>	Trunking Mode - Digital Local: The radio operates under a single BS.
<b>DM-R</b>	Direct mode: The single frequency repeat (SFR) feature is enabled on the current channel.
	The Mode Automatic Switch feature is enabled.





#### Basic Status

Icon	Radio Status
	The Dual-Tone Multi-Frequency (DTMF) keypad is enabled.
	There is no signal in DM, RM, or TM-DW

Icon	Radio Status
	mode.
	The number of bars indicates the signal strength in DM, RM, or TM-DW mode.
	There is no signal in TM-DL mode.
	The number of bars indicates the signal strength in TM-DL mode.
	The radio operates in high power mode.
	The radio operates in low power mode.
	An accessory is connected.
	The Global Positioning System (GPS) feature is enabled, and the radio receives GPS data.
	The GPS feature is enabled, but the radio receives no GPS data.
	The radio is in emergency mode.
	The radio is roaming.
	The radio is detecting sites for roaming.
	The Scrambler or Encrypt feature is enabled.
	The Over The Air Encrypt feature is enabled.
	The radio is scanning or hunting.
	The radio stays on a non-priority channel.
<b>P<sub>1</sub></b>	The radio stays on priority channel 1.







Icon	Radio Status
<b>P<sub>2</sub></b>	The radio stays on priority channel 2.
	The Non-dedicated Control Channel feature is enabled.
	The Voice Operated Transmit (VOX) feature is enabled.
	The Monitor feature is enabled.
	The speaker is turned on.
	The radio operates in silent mode.
	The Loudness and Quality Optimizer (LQO) feature is enabled.
<b>R</b>	The SFR feature is enabled.

#### Short Data Service

Icon	Radio Status
	There is/are unread short message(s).
	The Inbox is full.
	There is/are unread work order(s).
	The work order list is full.

#### Call Service

Icon	Radio Status
	There is/are alert call(s).

Icon	Radio Status
	The Call Divert feature is enabled.
	A full-duplex call is in progress.
	A private call is in progress or a private contact is on the contact list.
	A group call is in progress or a group contact is on the contact list.
	An all call is in progress or an all call contact is on the contact list.
	An include call is in progress.

## Checking LED Indications

LED Indicator	Radio Status
Flashes green	The radio is being turned on.
Flashes green slowly	The radio is standby in trunking mode.
Glow green	The radio is receiving.
Glow red	The radio is transmitting.
Flashes red	The calling radio is establishing a call in trunking mode.
Flashes orange slowly	The radio is scanning, hunting, or roaming.
Flashes orange rapidly	<ul style="list-style-type: none"> <li>Conventional mode: The radio is operating in emergency mode.</li> <li>Trunking mode: The called radio is establishing a Full Off Air Call Set.</li> </ul>

LED Indicator	Radio Status
	Up (FOACSU) call.
Glow orange	Call hang time: No voice is being transmitted or received on the channel during a call. Within such a period, you can press and hold the <b>PTT</b> key and speak.

## Call Services

When you are speaking during a call, keep the microphone about 2.5 to 5 cm away from your mouth. This ensures optimal voice quality on the receiving radio.

### NOTE

If the radio is not registered or attached, or an empty group is selected, you cannot initiate a call.

## Group Call

A group call is a call from an individual user in a group to all the other members in the group.

### Initiating a Group Call

You can initiate a group call in conventional mode and trunking mode. When you initiate a group call, the radio displays .

#### Conventional Mode

- Through the Preset Contact
  - Press and hold the **PTT** key to initiate a group call to the preset group contact on the current channel.
- Through the Contact List



- Press the preprogrammed **Contact List/Favorites** key or go to **Menu > Contact > Contact List/Favorites**.
  - Select the required group contact from the list.
  - Press and hold the **PTT** key.
- Through the Manual Dial
    - Go to **Menu > Contact > Manual Dial**, or go to **Menu > Settings > Radio Set > Keypad Mode**, and then select **Enable**.
    - Press  to switch into numeric mode on the home screen.
    - Enter the group call ID.
    - Press and hold the **PTT** key.

#### Trunking Mode

- Through the Preset Contact





Press and hold the **PTT** key to initiate a group call to the standby group contact.

- Through the Contact List

- To access the group contact list, you can press the preprogrammed **Favorites** key; go to **Menu > Contact > Contact List/Favorites**; press the preprogrammed **Current Subgroup Contact** key or **Back/Subgroup** key; or go to **Menu > Subgroup**.
- Select the required group contact from the list.
- Press  on the radio or press /PTT key on the palm microphone or the handset.

- Through the Call Logs

- Go to **Menu > Call Logs > Outgoing/Incoming > Outgoing List/Incoming List**

2. Select the required group contact from the list.
  3. Press  on the radio or press /PTT key on the palm microphone or the handset.
- Through the Manual Dial
    1. Go to **Menu > Settings > Radio Set > Keypad Mode**, and then select **Enable**.
    2. Enter the group call number on the home screen.
    3. Press  on the radio or press /PTT key on the palm microphone or the handset.

## Receiving a Group Call

### Conventional Mode

When receiving a group call, the radio displays . You can listen to a received group call without any operation.

### Trunking Mode

When receiving a group call, the radio establishes the call automatically. After the call is established successfully, the radio displays .

## Ending a Group Call

In conventional mode and trunking mode, a group call automatically ends when the call hang time expires.

In trunking mode, a group call also ends in any of the following cases:

- The calling party ends the call.
- The call duration exceeds the preset time.
- The base station signal is lost.

- The calling party selects an empty group with the **Group Selector** knob.
- A preemptive or emergency call interrupts the call.
- The calling party changes the contact with the Clear Down feature enabled.

## Private Call

A private call is a call from an individual user to another individual user.

### Initiating a Private Call

You can set up a full duplex private call and a half duplex private call.



Full duplex private call: The called party and the calling party can talk at the same time.

Half duplex private call: The called party and the calling party cannot talk at the same time.

#### NOTE

Full duplex private call is available only for the duplex mobile radio.

You can press the preprogrammed **Call Setup** key or go to **Menu > Settings > Radio Set > Call Setup**, and then select **Half Duplex** or **Full Duplex** as the call setup mode.

You can initiate a private call in conventional mode and trunking mode. When you initiate a private call, the radio displays  (half duplex), or  (full duplex).

### Conventional Mode

- Through the Preset Contact

Press and hold the **PTT** key to initiate a private call to the preset private contact on the current channel.



- Through the Contact List
  1. Press the preprogrammed **Contact List/Favorites** key, or go to **Menu > Contact > Contact List/Favorites**.
  2. Select the required group private from the list.
  3. Press and hold the **PTT** key.
- Through the Call Logs
  1. Go to **Menu > Call Logs > Outgoing/Incoming > Outgoing List/Incoming List**.
  2. Select the required private contact from the list.
  3. Press and hold the **PTT** key.
- Through the Manual Dial
  1. Go to **Menu > Contact > Manual Dial**, or go to **Menu > Settings > Radio Set > Keypad Mode**, and then select **Enable**.
  2. Press  to switch into numeric mode on the home screen.
  3. Enter the private call number.
  4. Press and hold the **PTT** key.

### Trunking Mode



- Through the Preset Contact

Press and hold the **PTT** key to initiate a private call to the standby private contact.



- Through the Contact List
  1. Press the preprogrammed **Contact List/Favorites** key, or go to **Menu > Contact > Contact List/Favorites**.
  2. Select the required private contact.

3. Press  on the radio or press /PTT key on the palm microphone or the handset.

- Through the Call Logs



1. To access the appropriate call log, go to **Menu > Call Logs > Outgoing/Incoming > Outgoing List/Incoming List**, or press the preprogrammed **ReDial Call Log** key or **BackDial Call Log** key.
2. Select the required private contact.
3. Press  on the radio or press /PTT key on the palm microphone or the handset.

- Through the Manual Dial

1. Go to **Menu > Settings > Radio Set > Keypad Mode**, and then select **Enable**.
2. Enter the private call number on the home screen.
3. Press  on the radio or press /PTT key on the palm microphone or the handset.

## Receiving a Private Call



### Conventional Mode





When receiving a private call, the radio displays  (half duplex), or  (full duplex). You can listen to a received private call without any operation.

### Trunking Mode

You can listen to a call in different ways varying with the setup mode of the call:

- Full Off Air Call Set-Up (FOASCU)

When receiving a FOASCU private call, the radio rings and vibrates, and displays  (half duplex), or  (full duplex).

To answer the call, press  on the radio or press  or press and hold the **PTT** key on the palm microphone or the handset within the preset time. After the call is successfully established, the radio emits a tone and displays . If you do not answer the call, the radio displays .

- Off Air Call Set-Up (OASCU)

When receiving an OASCU private call, you can listen to it without any operation. After the call is successfully established, the radio displays .

## Ending a Private Call

In conventional mode and trunking mode, a private call automatically ends when the call hang time expires.

In trunking mode, a private call also ends in any of the following cases:

- The calling or the called party ends the call.
- The call duration exceeds the preset time.
- The base station signal is lost.
- The calling party or the called party selects an empty group with the **Group Selector** knob.
- A preemptive or emergency call interrupts the call.
- The calling party changes the contact with the **Clear Down** feature enabled.

## All Call

### Conventional Mode

An all call is a call from an individual user to all other users in a specific BS, area, or system.

### Trunking Mode

An all call is a call from an individual user to all other users in a specific BS, area, or system.

According to whether the called party can respond, an all call is classified into the following two types:

- Broadcast All Call: The called party cannot respond to the call.
- General All Call: The called party can respond to the call.

To select an all call type, go to **Menu > Settings > Radio Set > All Call**, and then select **Broadcast All Call** or **General All Call**.

### NOTE

The All Call service needs to be enabled by your dealer.

## Initiating an All Call

You can initiate an all call in conventional mode and trunking mode. When you initiate an all call, the LCD displays the icon .

### Conventional Mode







- Through the Preset Contact

Press and hold the **PTT** key to initiate a group call to the preset group contact on the current channel.

- Through the Contact List

1. Press the preprogrammed **Contact List/Favorites** key or go to **Menu > Contact > Contact List/Favorites**.
2. Select the required all call contact from the list.
3. Press and hold the **PTT** key.

## Trunking Mode

- Through the Manual Dial
  1. Go to **Menu > Settings > Radio Set > Keypad Mode**, and then select **Enable**.
  2. Enter the all call ID on the home screen.
  3. Press  on the radio or press //**PTT** key on the palm microphone or the handset.
- Through the Call Logs
  1. Press the preprogrammed **ReDial Call Log** key to access the all call record.
  2. Select the required group contact from the list.
  3. Press  on the radio or press //**PTT** key on the palm microphone or the handset.

## Receiving an All Call

When receiving an all call, the radio displays . You can listen to a received all call without any operation.

## Ending an All Call

In conventional mode and trunking mode, an all call ends when the calling party releases the **PTT** key.

In trunking mode, an all call also ends in any of the following cases:

- The call duration exceeds the preset time.
- The base station signal is lost.

- The calling party selects an empty group with the **Group Selector** knob.
- A preemptive or emergency call interrupts the call.
- The calling party changes the contact with the Clear Down feature enabled.

## Broadcast Call (Trunking Only)

A broadcast call is a special group call to which the called party cannot respond. Only the calling party can speak by pressing and holding the **PTT** key.





### NOTE







The Broadcast Call service needs to be enabled by your dealer.

## Initiating a Broadcast Call

You can initiate a broadcast call only in trunking mode.

When you initiate a broadcast call, the radio displays .

- Through the Contact List
  1. To access the group contact list, you can press the preprogrammed **Favorites** key; go to **Menu > Contact > Favorites**; press the preprogrammed **Current Subgroup Contact** key or **Back/Subgroup** key; or go to **Menu > Subgroup**.
  2. Select the **Broadcast Group Call** as the **Call Type**.
  3. Press  on the radio or press /**PTT** key on the palm microphone or the handset.
- Through the Manual Dial

1. Go to **Menu > Settings > Radio Set > Keypad Mode**, and then select **Enable**.
  2. Enter the broadcast call ID.
  3. Press  on the radio or press //**PTT** key on the palm microphone or the handset.
- Through the Call Logs
    1. To access the group call record, go to **Menu > Call Logs > Outgoing/Incoming > Outgoing List/Incoming List**, or press the preprogrammed **ReDial Call Log** key or **BackDial Call Log** key on the home screen.
    2. Select the required call record.
    3. Select the **Broadcast Group Call** as the **Call Type**.
    4. Press  on the radio or press //**PTT** key on the palm microphone or the handset.

## Receiving a Broadcast Call

When receiving a broadcast call, the radio establishes the call automatically.

After the call is established successfully, the radio displays .

## Ending a Broadcast Call

A broadcast call ends in any of the following cases:

- The call duration exceeds the preset time.
- The calling party ends the call.
- The base station signal is lost.
- The calling party selects an empty group with the **Group Selector** knob.

- A preemptive or emergency call interrupts the call.
- The calling party changes the contact with the Clear Down feature enabled.

## Include Call (Trunking Only)

An include call is a special group call initiated to another group in call hang time of an ongoing group call, and the invited group joins the ongoing call. An include call enables the same Talk Priority and Clear Down feature as a group call. Currently, only group call supports the include call service.

Your radio can initiate an include call only after being authorized by your dealer.

For operation details, see "Group Call" on page 5.

## Phone Call



A phone call is a call between a radio and a phone. If a repeater is connected to a PSTN/PABX gateway and joins the PSTN/PABX system, the radio can communicate with the phone through the repeater.

### Initiating a Phone Call

You can initiate a phone call in conventional mode and trunking mode. When you initiate a phone call, the radio displays the dialing information in conventional mode and  in trunking mode.

#### Conventional Mode

- Through the Manual Dial
  1. Send the access code to connect your radio to the phone system. You can enable the DTMF keypad to enter the access code, and then press



- the **PTT** key. Or with the One-Key Connect feature enabled, press  on the radio or  on the palm microphone or the handset.
2. Enter the phone call ID through numeric keypad.
  3. Press and hold the **PTT** key.

- Through the Contact List



1. Enable the DTMF keypad and enter the access code. Then the radio displays the dialing information and accesses the phone system.
2. Go to **Menu > Phone > Phone Contact**, and select the required contact from the list.
3. Press and hold the **PTT** key.

### Trunking Mode





- Through the Contact List

1. Press the preprogrammed **Favorites/Private Contact** key, go to **Menu > Contact > Favorites/Private Contact**.
2. Select the required group contact from the list.
3. Press  on the radio or press /**PTT** key on the palm microphone or the handset.

- Through the Manual Dial

1. Go to **Menu > Settings > Radio Set > Keypad Mode**, and then select **Enable**.
2. Enter the PSTN/PABX call number on the home screen.
3. Press  on the radio or press //**PTT** key on the palm microphone or the handset.

When the Phone Dial feature is enabled by your dealer, you can do as follows:

1. Go to **Menu > Contact > Phone Dial**.
  2. Press  and enter the customized PSTN/PABX number between 1-digit to 20-digit.
  3. Press  on the radio or press /**PTT** key on the palm microphone or the handset.
- Through the Call Logs
    1. To access the call record, go to **Menu > Call Logs > Outgoing/Incoming/Missed > Outgoing List/Incoming List/Missed List**, or press the preprogrammed **ReDial Call Log** key or **BackDial Call Log** key on the home screen.
    2. Select the required call record.
    3. Press  on the radio or press /**PTT** key on the palm microphone or the handset.

#### NOTE

- To enable the DTMF keypad, press the preprogrammed **DTMF Keypad** key or go to **Menu > Phone > DTMF Keypad**.
- The radio uses access code and de-access code to join and exit the phone system. The codes are enabled by your dealer.

## Receiving a Phone Call



### Conventional Mode

After receiving a phone call, the radio sends connect code and joins the phone system. Then you can listen to the phone call.

### Trunking Mode

After receiving a PSTN/PABX call, the radio displays .





You can establish the call by pressing  on the radio or pressing /PTT key on the palm microphone or the handset within the preset time.

After the call is established successfully, the radio displays .

## Ending a Phone Call

### Conventional Mode

In conventional mode, a phone call ends in any of the following cases:

- The radio enters disconnect code using the numeric keypad.
- If the One-Key Disconnect feature is enabled, press  on the radio or press  on the palm microphone or the handset.
- The phone is hung up during communication.

### Trunking Mode

In trunking mode, a phone call ends in any of the following cases:

- The call duration exceeds the preset time.
- The calling party ends the call.
- The base station signal is lost.
- The calling party selects an empty group with the **Group Selector** knob.
- A preemptive or emergency call interrupts the call.
- The calling party changes the contact with the Clear Down feature enabled.

## Call on Analog Channel (Conventional Only)

### Call Without Signaling

On an analog channel without signaling, you can initiate a call to all the other users on the channel. Do as follows:

1. Rotate the **Channel Selector** knob to select the required channel.
2. Press and hold the **PTT** key, and speak into the microphone.

### Call With Signaling

On an analog channel with signaling, you can initiate a call to a specific contact on the channel. Do as follows:

1. Rotate the **Channel Selector** knob to select the required channel.
2. Press **OK/Menu** key, and go to **Contact > Contact List**.
3. Select the target contact.
4. Press and hold the **PTT** key, and speak into the microphone.

## Message Services

The Message feature allows you to send and receive the following types of messages in trunking mode or on a digital channel in conventional mode:

- New messages: messages created using the keypad.
- Quick text messages: frequently used messages predefined by your dealer and editable.
- Status messages (trunking only): frequently used messages predefined by your dealer and not editable.

## Viewing a Message

To view a newly received message on the home screen, directly press the **OK/Menu** key.

To view received message from the InBox, sent messages, or saved messages, do as follows:

1. Go to **Menu > Message > InBox/OutBox/Drafts > InBox List/Outbox List/Drafts List**
2. Select the required message.

## Sending a Message

### Sending a Text Message

1. Go to **Menu > Message > New Msg.** and then type the text.
2. Press the **OK/Menu** key, and then select **Send**.
3. Select the required contact, and then press the **OK/Menu** key.

#### NOTE

Instead of directly sending the new message, you can also select **Save** in conventional mode or select **Save to Drafts** or **Save to QuickText** in trunking mode to save the message, and send it later.

### Sending a Quick Text Message

1. Go to **Menu > Message > Quick Text**, and then select the required quick text message.
2. (Optional) Edit the message, and then press the **OK/Menu** key.
3. Select **Send**, and then select the required contact.
4. Press the **OK/Menu** key.

**NOTE**

You can send status message by manual dialing. To input a number complying with the dialing rules, consult your dealer for more details.

## Deleting a Message

### Deleting Text Messages

To delete a message from the InBox, OutBox, or Drafts, do as follows:

1. Go to **Menu > Message > InBox/OutBox/Drafts > InBox List/Outbox List/Drafts List**.
2. Select the required message, and then press the **OK/Menu** key.
3. Select **Delete**, and then press the **OK/Menu** key.

### Deleting Quick Text Messages

In trunking mode, you can go to **Message > Quick Text**, select the required quick text message, and then delete it.

## General Features

The features supported by the radio vary with the operation mode. For details, see the following table.

Feature	Conventional		Trunking
	Digital	Analog	
Password	√	√	√
Backlight, Brightness, LED Indicator, Alert Tone	√	√	√

Feature	Conventional		Trunking
	Digital	Analog	
Day/Night Mode	√	√	√
Power Level	√	√	√
VOX	√	√	√
Rent	√	√	√
Send Alias	√	×	√
Auto Add Contact	√	×	√
ESN Check in Idle	×	×	√
Any Call	×	×	√
User Assignment ID	√	×	√
Talk Around	√	√	×
Real-time Clock (RTC)	×	×	√
SPK Selection	√	√	√
MIC Selection	√	√	√
Mic AGC	√	√	√
LQO	√	√	√
Always Treble Boost	√	√	√
3-Band Equalizer	√	√	√
Private Call, Group Call, All Call	√	×	√
Telephone Call	√	√	√
Broadcast Call	×	×	√

Feature	Conventional		Trunking
	Digital	Analog	
Include Call	×	×	√
Call Without Signaling	×	√	×
Call With Signaling	×	√	×
Text Message	√	×	√
Status Message	×	×	√
Quick Text	√	×	√
One Touch Call/Menu	√	√	√
Quick Dial	√	√	√
Contact	√	√	√
Scan	√	√	×
Hunt	×	×	√
Background Hunt, Homestation Hunt, Multi-site Handover	×	×	√
Ambience Listening	×	×	√
Time-out Timer (TOT)	√	√	√
Busy Channel Lockout	√	√	×
Customized Single Tone	√	√	×
Priority Interrupt	√	×	×

Feature	Conventional		Trunking
	Digital	Analog	
Pseudo Trunking	√	×	×
eXtended Pseudo Trunk (XPT) System	√	×	×
Dual-slot Data Transmission	√	×	×
Single Frequency Repeat(SRF)	√	×	×
Roam	√	×	√
Work Order	√	×	√
Clarity Transmission	√	×	√
Data Inquiry	×	×	√
Call Divert	×	×	√
Call Priority	×	×	√
Dynamic Group Number Assignment (DGNA)	×	×	√
GPS	√	√	√
Position	√	√	√
Query Location	√	×	×
Query Neighbors	×	×	√
GPS Msg	√	×	√
Voice W/Location	√	×	√
Call Location	√	×	√

Feature	Conventional		Trunking
	Digital	Analog	
GPS Report	√	×	√
Quick GPS	√	×	×
Ignition Sense	√	√	√
Public Address	√	√	√
Horn & Lights	√	√	√
Emergency Call	√	√	√
Lone Worker	√	√	√
Encrypt	√	×	√
Scrambler	×	√	×
Stun	×	√	√
Revive	√	√	√
Kill	√	×	√
Emergency Erase Data	√	√	√
Alert Call, Radio Check, Remote Monitor	√	×	×
Comandor	×	√	×
Monitor	×	√	×
Squelch Off	×	√	×
Adjust Squelch Level	×	√	×
CTCSS/ CDCSS	×	√	×

## Radio Settings

Go to **Menu > Settings > Radio Set**. You can configure the following frequently used features on the Radio Set menu. For details, see the following table.

Feature	Description	Operation
Password	The feature allows you to create a power-up password. The radio will be locked when the wrong password is entered up to the predefined times. To reuse the radio, you can consult your dealer to reset the password.	To set a new password, go to <b>Password &gt; On/Off</b> , select <b>On</b> , and enter the password. (The default password is 88888888.)  To change the password, go to <b>Password &gt; Password Set</b> , enter your old password and new password.
Backlight	The feature is designed to illuminate the LCD and the keypad.	Go to <b>Backlight &gt; Off/On/Timed</b> .
Brightness	The feature allows you to set the LCD brightness.	Go to the <b>Brightness</b> menu, and press the <b>Up/Down Key</b> to adjust the brightness.
Day/Night	The feature allows	Go to <b>Day/Night &gt;</b>

Feature	Description	Operation
Mode	you to set the work mode of the LCD display. The LCD brightness is subject to the mode.	<b>Day Mode/Night Mode.</b>
LED Indicator	The feature allows you to identify the radio status by means of visual indication.	Go to <b>LED &gt; Enable/Disable.</b>
Alert Tone	The feature allows you to identify the radio status by means of audible indication.	Go to the <b>Tone</b> menu, access the required alert tone type, and choose <b>Enable</b> and set the volume level.
Power Level	The feature allows you to set the TX power level of the radio as High or Low.	Go to <b>Power Level &gt; High/Low.</b>
VOX	The feature allows you to transmit voice without pressing and holding the <b>PTT</b> key. The radio automatically transmits voice when the volume reaches the preset level.	<ol style="list-style-type: none"> <li>Go to <b>VOX &gt; On/Off</b>, and enable the <b>VOX</b>.</li> <li>Go to <b>VOX &gt; Gain Level</b>, and select the internal <b>MIC</b> or external</li> </ol>

Feature	Description	Operation
		<b>MIC</b> to adjust the sensitivity of microphone transmission.
Rent	The feature allows you to rent a radio from a dealer. When the rental time expires, the radio will be disabled.	Go to <b>Rent &gt; Rent Query</b> to check the remaining rental time.
User Assignment ID	The feature allows you to input an ID for your radio so as to identify different radio users.	If the feature is enabled by your dealer, you need to enter the ID upon power-on every time.
Talk Around	The feature allows you to continue communication in <b>DMO</b> mode, when the repeater malfunctions or your radio is out of the repeater's coverage.	Go to the <b>Talk Around</b> menu to enable or disable the feature.
Send Alias	The feature allows you to send the radio alias during call. The called party can view	Go to the <b>Send Alias</b> menu to enable or disable the feature.

Feature	Description	Operation
	the alias on the display and identify the calling party.	
Auto Add Contact	The feature allows the called party to automatically add the calling party into the contact list, if the calling party has enabled the send alias feature.	Go to the <b>Auto Add Contact</b> menu to enable or disable the feature.
ESN Check in Idle	When the radio is requesting registration or after the radio registers successfully, it will respond to the trunking system's ESN check.	Go to <b>ESN Check in Idle &gt; Enable/Disable.</b> When the feature is disabled, the radio can only respond to the ESN check during registration request.
Any Call	The feature allows the radio to initiate a call to a contact whose ID may not be in the radio's contact list.	<ul style="list-style-type: none"> <li>Go to <b>Any Call &gt; Individual Number</b>, select <b>Enable</b> to allow the radio to call any individual number, or select <b>Disable</b> to allow the radio to call the contacts in its</li> </ul>

Feature	Description	Operation
		<p>contact list and emergency ID only.</p> <ul style="list-style-type: none"> <li>Any call to telephone number is similar to individual number.</li> <li>Go to <b>Any Call &gt; Group Number</b>, select <b>Enable</b> to allow the radio to call any group contact, or select <b>Disable</b> to allow the radio to call the group contacts in the Subgroup and emergency ID only.</li> </ul>
RTC	This feature allows you to set the time display, view the time information and set the time format. The radio displays the time as HH:MM on the home screen, or --:--	<ul style="list-style-type: none"> <li>Go to <b>Date &amp; Time &gt; Time Display</b>, and enable or disable the time display on the home screen, call log and</li> </ul>

Feature	Description	Operation
	when no time data is received.	<p>message.</p> <ul style="list-style-type: none"> <li>Go to <b>Date &amp; Time &gt; Time View</b>. The radio displays <b>Time</b> as hh:mi:ss, and <b>Date</b> as yyyy-mm-dd.</li> <li>Go to <b>Date &amp; Time &gt; Time Format</b>, and select 24-hour or 12-hour notation.</li> <li>Go to <b>Date &amp; Time &gt; Time Zone</b>, and set the local time zone.</li> </ul>

## Audio Settings

### Switching the Audio Selection

The audio types of the radio include microphone and speaker. If the radio is connected to the audio accessory, you can switch the audio selections when using microphone and speaker.

To set the way the radio uses the external or internal microphone, you can see the following four ways:

- Follow PTT:** When you transmit voice through the radio's **PTT** key, the radio uses the internal microphone; when you transmit voice through the audio accessory, the radio uses the external microphone.
- Only Internal:** The radio uses only the internal microphone and speaker.
- Only External:** The radio uses only the audio accessory's microphone and speaker, such as earpiece and remote speaker microphone.
- External First:** When an audio accessory is connected, the radio uses the external speaker; otherwise, it uses the internal speaker.

To select the way the radio uses the external or internal microphone, you can do either of the following:

- Go to **Menu > Settings > Radio Set > MIC & SPK**, select **MIC Selection** or **SPK Selection**, and then choose the way on your actual requirements.
- Press the preprogrammed **Mic Set Switch** key and the **SPK Set Switch** key to change the audio selection.

### Setting Microphone

Mic Automatic Gain Control (AGC) allows the calling radio to control the voice input gain to a proper range during transmission, so as to provide improved voice with proper volume for the called party. The feature ensures a stable voice even in noisy environment.

To enable the feature, go to **Menu > Settings > Audio Set**, and then select the **Digital Mic AGC** or **Analog Mic AGC**.

## Audio Optimization

### Enabling LQO

The feature allows the radio to automatically adjust the voice output level to fit different environment.

To enable the feature, you can do one of the followings:

- Go to **Menu > Settings > Audio Set > LQO**.
- Press the preprogrammed **LQO** key.



#### NOTE

When the radio is connected to audio accessories such as earpiece and palm microphone, the feature is disabled.

### Enabling Always Treble Boost

The feature allows the radio to output louder voice automatically for audio clarity irrespective of the surrounding environment conditions.

To enable the feature, go to **Menu > Settings > Audio Set > Audio Optimization > Treble Boost**.



#### NOTE

The feature cannot work at the same time with LQO and 3-Band Equalizer.

### Configuring 3-Band Equalizer

The feature allows you to adjust the balance between frequency components within an audio signal from the radio, so as to optimize the voice quality and satisfy the demands of users working in different environments.

To achieve the optimal equalization, you might process the gain of high/mid/low frequency signal in different situations. The following table lists the recommended

value for three parameters. You can also set the value according to the actual requirements.

Seminar	dBGain for Low Frequency	dBGain for Mid Frequency	dBGain for High Frequency
Square	0	3	5
Indoor	3.5	1.5	-1.5
Downtown	2	2	8

To configure the feature, do as follows:

1. To enable the feature, go to the **Menu > Settings > Audio Set > Audio Optimization > 3-Band Equalizer**.
2. To adjust the audio gain, go to the **3-Band Equalizer** menu and set the gain value for high/mid/low frequency (Rang: -8db to +8db) as shown in the above table.

## One Touch Call/Menu

The **One Touch Call/Menu** feature allows you to press the preprogrammed **One Touch Call/Menu** key to quickly access a service assigned by your dealer, such as initiating a call, sending a message and switching to a function menu.

The services available for assignment are as follows:

- Conventional Mode

On the analog channel, you can make a all to a 5-tone or 2-tone contact.

On the digital channel, you can make a group call, private call and an all call; send a quick text and GPS message; send the command of alert call, radio check, remote monitor, radio enable, radio disable to a private

contact; and switch to a function menu such as message and contact list.



#### NOTE

To initiate a one touch call on the digital channel in conventional mode, you need to press the **PTT** key after pressing the preprogrammed **One Touch Call/Menu** key.

- Trunking Mode

You can make a private call, group call, all call, broadcast call and emergency call; send a quick text and a status message; switch to a function menu or realize a predefined feature.

To configure this feature, do either of the following:

- Go to **Menu > Settings > Radio Set > Keypad Mode**, and select **One Touch Call/Menu**. Then press numeric keys on the home screen to activate the predefined feature.
- Press the preprogrammed **One Touch Call/Menu** key.

## Scan

In conventional mode, the Scan feature allows you to listen to activities on other channels, keeping track of your team members.

### Enabling Scan

To enable the feature, do either of the following:

- Go to **Menu > Scan > Scan On/Off**, and select **On**.
- Press the preprogrammed **Scan** key.

With the feature enabled, the radio searches the scan list preset for the current channel, and the LCD displays , and the LED indicator slowly flashes orange. When detecting activities on a channel, the radio stays on it, and

the LED indicator glows green. If the radio stays on a non-priority channel, the LCD displays . If the radio stays on the priority channel 1 or 2, the LCD displays P<sub>1</sub> and P<sub>2</sub>.

#### NOTE

If you do not want to listen to the activities on a channel, press the preprogrammed **Nuisance Temporary Delete** key to temporarily remove the channel from the scan list.

## Setting Scan List

The Scan list lists at most 32 channels (including analog and digital channels) for radio to scan. To delete or add a channel or set a priority channel, go to **Menu > Scan > Scan List** and access the **Edit/View** menu.

- Select **Add CH** in the current scan list to add a channel.
- Select a channel in the current scan list. If you do not want to scan the channel, select **Delete CH** to delete it. If you want to scan the channel with priority, select **Edit Prio Ch** and choose **Set PrioCh 1** or **Set PrioCh 2**.

## Hunt

In trunking mode, the radio must register with a BS for normal operation. The radio can access versatile TSCC strategies to ensure a quick registration.

### Selecting a Hunt Mode

Before registering, the radio will hunt through the control channels for available base stations.

Two hunting plans are adoptable: Fixed Trunking Station Control Channel (Fixed TSCC) and Flexible Trunking Station Control Channel (Flexible TSCC).

When the radio has unified frequency plans, it can use Fixed TSCC. When the radio does not have unified frequency plans, it can use the Flexible TSCC.

The following lists three hunt modes available in the Fixed TSCC:

- **Short Hunt**: allows the radio to hunt the fixed TSCC in the defined hunt list.
- **Comprehensive Hunt**: allows the radio to hunt all the channels within the preset frequency range.
- **Team Hunt**: allows the radio to hunt the fixed TSCC in the defined team hunt list.

You can go to **Menu > Scan > TSCC Hunt**, and select **Short Hunt**, **Comprehensive Hunt**, or **Team Hunt** according to your actual requirement.

### Enabling Background Hunt, Homestation Hunt, or Multi-site Handover

After the successful registration, the radio can enable the following hunt modes to ensure a seamless communication:

- **Background Hunt**: The feature allows an idle radio to keep detecting the signal strength of the base station with which it registers. If the signal strength goes below the threshold level preset by the dealer, the radio will automatically hunt for an adjacent base station with stronger signal strength and register with it.
- **Homestation Hunt**: In an overlapping area, it is recommended that you request the dealer to set the

frequently used channel as the homestation channel and enable the Homestation Hunt feature. In this case, the radio operating on another channel switches back to the homestation channel after the signal strength of the homestation channel reaches the preset threshold.

- **Multi-site Handover**: The signal strength received from a base station may fluctuate due to position change and affect the radio's communication quality. In such occasions, the feature allows the radio to automatically register with the base station with stronger signals to ensure a seamless communication.

To enable a hunt mode, you can do either of the following:

- Go to **Menu > Hunt**, and select **Background Hunt**, **Homestation Hunt**, or **Handover** according to your actual requirement.
- Press the preprogrammed **Background Hunt**, **Homestation Hunt**, or **Multi-site Handover** key.

## Contact Management

Contact management allows you to view, add, edit, or delete a contact.

#### NOTE

- The ID and alias of a new contact must be unique.
- You can also save the numbers from the Call Logs into the contact list.

### Favorite Contact

A Favorite Contact is your frequently used contact.

## Viewing, Editing or Deleting Favorite Contact

- In conventional mode, go to **Menu > Contact > Favorites** or press the preprogrammed **Favorites** key.
- In trunking mode, go to **Menu > Contact > Favorites**, and select the required contact or **Folder Management**.

## Adding Favorite Contact

- In conventional mode, go to **Menu > Contact > Favorites > Add Contact**.
- In trunking mode, go to **Menu > Contact > Favorites > Folder Management > Add Contact**, and select the required contact.

## Private Contact

### Viewing, Editing or Deleting Private Contact

- In conventional mode, go to **Menu > Contact > Contact List**, or press the preprogrammed **Contact List** key.
- In trunking mode, go to **Menu > Contact > Private Contact**, or press the preprogrammed **Private Contact** key to access the private contact list.

### Adding Private Contact

- In conventional mode, go to **Menu > Contact > New Contact**, and input the ID and alias of the contact and save it.
- In trunking mode, go to **Menu > Contact > New Contact**, and input the ID of the contact, select the call type as **Private**, and then input the alias of the contact and save it.

## Phone Contact

### Viewing, Editing or Deleting Phone Contact

- In conventional mode, go to **Menu > Phone Contact**, or press the preprogrammed **Phone List** key.
- In trunking mode, go to **Menu > Contact > Private Contact**.

### Adding Phone Contact

- In conventional mode, go to **Menu > Phone > New Contact**, and then input the ID and alias of the contact and save it.
- In trunking mode, go to **Menu > Contact > New Contact**, input the ID of the contact, select the call type as **PSTN/PABX**, and then input the alias of the contact and save it.

## Priority Group

Priority group is a special type of group call with a priority level. In trunking mode, the radio participates in group calls according to group priority levels.

If the feature is enabled by your dealer, go to **Menu > Priority Group > Enable/Disable** to configure the feature, and then select **Level 1**, **Level 2** or **Level 3** to set the priority level of a group call.

## TOT

The TOT feature allows the radio to automatically stop transmission and keep beeping when the period preset by your dealer expires. To stop beeping, release the **PTT** key. You need to wait for a certain period (also preset by your dealer) to initiate transmission again.

This feature is enabled by default, aiming to prevent a radio user from occupying a channel for an extended period. It also avoids potential radio damage caused by overheating.

## Busy Channel Lockout

The Busy Channel Lockout feature prevents you from talking on a channel that is already in use. The radio keeps beeping if you press and hold the **PTT** key when the current channel is occupied by other radios.

This feature is enabled by default, aiming to prevent interference from other radios on the same channel during transmission.

## Customized Single Tone

The Customized Single Tone feature allows you to customize the TX audio for emergency alarm or to target radio.

If this feature is enabled by your dealer, you can press and hold the preprogrammed **Customized Single Tone** key to send the TX audio to the current contact and release the key to stop sending.

## Priority Interrupt

The Priority Interrupt feature allows you to interrupt the ongoing activities (such as a call, a call hang status or remote monitor) on the current channel to free the channel, so as to make a new call or a new service.

This feature includes manual priority interrupt and auto priority interrupt.



## Manual Priority Interrupt

Press the preprogrammed **Manual Priority Interrupt** key to terminate the ongoing activities.

## Auto Priority Interrupt

Auto Priority Interrupt includes Emergency Priority Interrupt, Call Back Priority Interrupt, Message Priority Interrupt, Kill Priority Interrupt and All Call Priority Interrupt. When this feature is enabled by your dealer, you can interrupt an ongoing call using emergency call, call back, all call, or sending a message.

## Pseudo Trunk

The Pseudo Trunk feature allows the radio in repeater mode to select an idle time slot for communication. When one slot is busy, the radio, the radio automatically select the other time slot for communication. In this way, the feature improves channel utilization and decreases the interference to other ongoing calls on the channel.

To enable the feature, go to **Menu > Programming > Channel > Slot > Pseudo Trunk**.

## XPT System

XPT System is based on the digital conventional system. It connects multiple repeaters to create an extended pseudo trunk system. The system allows the radio to communicate through any of the repeaters in the site by sharing the logic channels of these repeaters, so as to increase the channel utilization and extend the communication capacity. In such case, a dedicated control channel is no longer required.

XPT system is categorised as single-site trunking system and multi-site trunking system.

- Single-site trunking system consists of a master repeater and multiple slave repeaters. These repeaters are connected by exchange devices.
- Multi-site trunking system consists of multiple single-site trunking systems. They are connected by the multi-site IP network.

The radio in the XPT system can support services including call, data, roam, emergency and priority interrupt. For detailed information, see the features in conventional mode.

## SRF

The SRF feature allows the radio in DMO mode to receive services on one time slot and then forwards them on the other, using the same frequency and code. With this feature enabled, the radio can repeat the voice, data or signaling even when it is out of range. In this way, the feature expands the communication coverage and saves frequency resources.

To enable the feature, you can press the preprogrammed **SRF** key or go to **Menu > Settings > Radio Set > SRF**. Then the radio displays "DM-R" and R.

If Auto SRF is enabled by your dealer for a channel, the radio automatically enables the SRF feature when switching to the channel.

### NOTE

The SRF feature is only available to the duplex radio.

## Dual-slot Data Transmission

The Dual-slot Data Transmission feature allows the radio to use two time slots on digital channels to transmit large amount of data. If only one slot is free, the radio automatically switches to the slot for data transmission.

To enable the Dual-slot Data Transmission or Dual-slot Clarity Transmission, go to **Menu > Settings > Radio Set > Dual Slot Data**

### NOTE

The dual-slot transmission feature is only applicable for data transmission and clarity transmission.

## Roam

### Conventional Mode

The Roam feature allows you to enjoy seamless communication across sites or networks.

- Enabling Roam

Press the preprogrammed **Roam** key or go to **Menu > Roam**. When the roam feature is enabled, the radio displays .

- Setting Roam List

Roam List is a group of channels under monitoring. Each list contains at most 32 channels.

To add or delete the channel in a roam list, go the **Menu > Roam > Roam List** and select the roam list.

### Trunking Mode

The Roam feature allows the radio to register with a non-home base station or network when it is on the move.

When the radio detects signal, it initiates to register. The radio displays .

This feature is enabled by your dealer.

## Clarity Transmission

The Clarity Transmission feature allows data transferred from one external device to another using the radio. The mobile radios serve as the transparent transmission channel for data exchange between external devices without any additional adjustment. This feature is enabled by your dealer.

## Conventional Mode

When the radio receives the data through the serial port, it transfers the data to a preset contact excluding an all call contact.

## Trunking Mode

When the radio receives the data through the serial port, it transfers the data to a preset private contact or group contact by using short data or packet data.

To enable or disable the feature, press the preprogrammed **Clarity Transmission Mode** key.

In the Clarity Transmission mode, the radio is capable of only transmitting or receiving data.

## Work Order

The Work Order feature allows you to receive a task from the dispatcher and report the latest task state to the dispatcher at each stage of the task.

## Viewing the Work Order

- Live View

When receiving a new work order, the radio displays  and a prompt box. You can view the newly received work order on the home screen directly.

- Menu View

To view the work order, go to **Menu > Work Orders > All Task/ New Task**. After the status of the new work order is updated, it moves away from **New Task** to appropriate menu option. You can view work order by the status alias.

## Reporting the Task Status

To report the task status, do either of the following:

- Go to **Menu > Work Orders** and select an available task status to report.
- Press the preprogrammed **Task Status** key (numeric key 0 to 9).

## Data Inquiry

The Data Inquiry feature allows you to query related information from a third party by sending the command or keyword.

To send inquiry command or keywords, go to **Menu > Inquiry**.

## Call Divert

The Call Divert feature allows you to divert an incoming private call to a designated radio.

To turn on this feature, do as follows:

1. Go to **Menu > Settings > Radio Set > Call Divert > On/Off**, and select **On**

2. Select **Divert ID**, and enter the ID using the keypad.
3. Press the **OK/Menu** key to select the call type as **Private ID, PABX, or PSTN**.

To turn off this feature, select **Off** under **Call Divert**.

## Call Priority

The Call Priority feature allows you to set the priority of voice services except emergency call. When all channels are occupied, the call requests are put in a queue according to their priorities. During queuing, the radio displays "Call Queued".

To set the priority, go to **Menu > Settings > Radio Set > Priority**, and then select one of the following as required: **Low, Medium, High, and Preemption**.

The Preemption option is available only when the Preemptive Call feature is enabled by your dealer. A preemptive call does not need to queue.

## DGNA

The DGNA feature allows you to initiate a call to or receive a call from a dynamic group temporarily created by a dispatcher. All the dynamic groups are saved in the DGNA menu.

The radio displays "DGNA Success!" when the dynamic group is added successfully and "DGNA Deleted" when the dynamic group is deleted. The added dynamic group is saved in a dynamic subgroup list under **Subgroup** on your radio.

For operations to initiate, receive or end a dynamic group call, see "Group Call" on page 5.

## Position

The Positioning feature allows you to collect the location information of the radio by using satellites.

The radio with COMPASS supports the BeiDou Navigation Satellite System, the GPS, and both the GPS and Beidou Navigation Satellite System. You can go to **Menu > Accessories > COMPASS > Position Sys** to select one system.



### NOTE

The feature is only available to the radio with COMPASS, GPS or GLONESS.

## Enabling Position

- In conventional mode, go to **Menu > Accessories > GPS/COMPASS**.
- In trunking mode, the feature is enabled by your dealer.

## Viewing Position

- Viewing the radio's position

Go to the **Menu > Accessories > GPS/COMPASS > Position**. You can view the location information of your radio (including its longitude, latitude, time, data and the number of visible satellites).

- Viewing the contact's position.

In conventional mode, go to **Menu > Accessories > GPS/COMPASS > Query Location**. You can view the location information of a nearby private contact (including alias, direction and distance).

In trunking mode, go to **Menu > Accessories > GPS/COMPASS > Query Neighbors**.

## Sending GPS Msg

- To send your location information to a contact by message in conventional mode, do as follows:

1. Go to **Menu > Accessories > GPS/COMPASS > Query Location > Contact List**.
2. Select the required contact in the list.
3. Press the **OK/Menu** key to send the message.

- To send your location information to a control center by message in trunking mode, do as follows:

1. Go to **Menu > Accessories > GPS/COMPASS > Position > GPS Msg**.
2. Press the **OK/Menu** key to access the interface.
3. Press the **OK/Menu** key.

## Voice w/Location

The Voice w/Location feature allows the radio to report its location information to the dispatch station when initiating a private call, group call or an emergency call.

To enable the feature, go to **Menu > Accessories > Voice w/Location**.

## Call Location

The Call Location feature allows the receiving radio to display the location information (including its direction, distance and geographic coordinates) of the transmitting radio. Before enabling this feature, the transmitting radio must enable the Voice w/Location feature.

To enable the feature and set display type, do as follows:

1. Go to **Menu > Accessories > GPS/COMPASS > Call Location > On/Off**.

2. Go to **Display Type** in the **Call Location** menu and select **16 Azimuth & Distance, Accur Azimuth & Distance** or **Talker Location**.

## GPS Report

The GPS Report feature allow the radio to report its location information to the control center or trunking system.

### Conventional Mode

You can report the GPS data by pressing the preprogramed **GPS Report** key. You can also enquire your dealer to configure the GPS trigger to allow the radio to report the GPS data automatically upon power on/off or according to the preset interval time or distance.

### Trunking Mode

If the GPS Active Report feature is enabled by your dealer, the radio reports the GPS data automatically when reaching a preset time or distance.

If the radio enables GPS Report in Voice, you can report GPS data during communication.

## Quick GPS

The Quick GPS feature allows all radios of the same dispatch station to transmit location information at specific time slices. To be specific, the Report Interval Time is divided into different time slices with the same time length, and the time slices are allocated to all radios of the dispatch station. In this way, the radios transmit positioning data to the dispatch station in order, improving transmission efficiency.

If your dealer configures the feature to a digital channel, the radio enters the quick GPS mode once it switches to the channel.

## Ignition Sense

The Ignition Sense feature controls the radio on/off and the **PTT** key enabled/disabled by starting or stopping your vehicle.

The following lists four types of ignition sense.

- **Ignition or Switch:** Allows you to turn the radio on or off by the engine or the **On-Off** key.  
To turn the radio on, start the engine or long press the **On-Off** key.  
To turn the radio off, stop the engine or press the **On-Off** key.
- **Ignition Only:** Allows you to turn the radio on or off by the engine.  
To turn the radio on, start the engine.  
To turn the radio off, stop the engine.
- **PTT Disable:** Allows you to enable or disable the **PTT** key by the engine.  
To enable the **PTT** key, start the engine.  
To disable the **PTT** key, stop the engine.
- **Disable Ignition Off:** Allows you to turn the radio on by the engine or the **On-Off** key, and allows you to turn the radio off only by the **On-Off** key.  
To turn the radio on, start the engine or long press the **On-Off** key.  
To turn the radio off, press the **On-Off** key.

## Public Address

The Public Address feature allows you to address a large public through the external speaker (connected to the accessory connector on the rear panel), if you hold down the **PTT** key and speak.



To enable the feature, press the preprogrammed **Public Address** key. To disable the feature, press the **Public Address** key again.



## Personal Safety Services

### Emergency

The Emergency feature allows you to ask for help from your companion or the control centre in case of emergency. With the highest priority, you can make an emergency call whenever your radio is transmitting or receiving.

In emergency mode, the radio transmits at high power by default. Based on different emergency indications, five emergency types are classified as follows. You can request your dealer for configuration according to your actual requirement.

Emergency Type	Description
Siren Only	The radio sounds shrill alarm tones and displays  and  .
Regular	The radio gives audible and visible indications.
Silent	The radio gives no audible or visible indication, and you cannot listen to a received call.

Emergency Type	Description
Silent w/Voice	The radio gives no audible or visible indication, but you can listen to a received call.
Alarm w/Siren	The radio sends an alarm, sounds shrill alarm tones and displays  and  .

In addition, you can request your dealer to set one of the following emergency modes:

Emergency Mode	Description
Alarm	Allows you to send an emergency alarm.
Call Only	Allows you to initiate an emergency call.
Alarm w/Call	Allows you to send an emergency alarm and initiate an emergency call.

The three emergency modes can be combined with any of the following emergency types: **Regular**, **Silent** and **Siren w/Voice**.

### Initiating an Emergency Call

You can press the preprogrammed **Emergency On** key to make an emergency call to the preset contact.

In trunking mode, you can also initiate an emergency call by going to **Menu > Contact > Favorites** to select a group call contact, set the call type **Emergency Call** and press the **PTT** key.

In the emergency mode of Alarm and Call Only, you can enable the Alarm w/Call to Follow feature. Then you can initiate an emergency call automatically by speaking into the microphone without pressing the **PTT** key. When the preset voice cycles for automatic emergency transmission expire, you can press the **PTT** key to make the emergency call again.

## Receiving an Emergency Call

You can listen to a received emergency call without any operation.

## Ending an Emergency Call

### Conventional Mode

The calling party can end an emergency call by the following ways:

- Pressing the preprogrammed **Emergency Off** key.
- Turning off the radio.

The called party can exit the emergency alert by the following ways:

- Pressing the **Back** key and then the **TK** key.
- Switching the channel.
- Turning off the radio.



#### NOTE

If the dealer enables the Send Emergency Exit Message feature, your radio will send an exit emergency message to the called party when you end a mistaken emergency alarm or emergency call.

## Trunking Mode

The calling party can end an emergency call by the following ways:

- Pressing the preprogrammed **Emergency Off** key.
- Turning off the radio.
- Rotating to an empty group using **Group Selector** knob.

The called party can exit the emergency alert by the following ways:

- Pressing the **Back** key and then the **TK** key.
- Turning off the radio.
- Switching the contact.

## Lone Worker

The Lone Worker feature allows the radio to automatically send an emergency alarm to your companion or the control center if you do not operate your radio within the preset time period. The feature ensures your safety when you work alone and encounter an emergency.

To enable the feature, do any of the following:

- Go to **Menu > Settings > Radio Set > Lone Worker > Enable**.
- Press the preprogrammed **Lone Worker** key.

## Horn & Lights

The Horn & Lights feature allows the radio to alarm through the external alarm devices (speaker or light), if the radio makes no operation within the preset time after

receiving an emergency alert, a call alert or a private call.

The following table lists three types of Horn & Lights. You can request your dealer for configuration according to your actual requirement.

Alarm Type	Description
Alarm Re-Arm	The Horn & Lights feature is enabled or disabled based on the setting upon the last power-off.
Non-Permanent Manual Re-Arm	The Horn & Lights feature must be enabled every time upon power-on.
Permanent External Alarm	The Horn & Lights feature is enabled whenever the radio is powered on.

To enable the feature, do one of the following:

- Go to **Menu > Accessories > Horn & Lights > On**
- Press the preprogrammed **Horn & Lights** key.

## Communication Security Services

### Encrypt

The Encrypt feature allows the radio to automatically encrypt transmitted voice or data. Only the receiving radio with the same key value or ID can decrypt the voice or data. This prevents eavesdropping and ensures communication privacy.

## Enabling the Encrypt

You can do either of the following:

- Go to **Menu > Settings > Radio Set > Encrypt > Enable/Disable**, and select **Enable**.
- Press the preprogrammed **Encrypt** key.

### NOTE

In conventional mode, if the Encrypt feature is enabled on a channel, the radio can automatically encrypt transmitted voice or data when switching to the channel.

## Configuring the Encrypt Key or Type

- In conventional mode, you can configure the encrypt key as follows:

### 1. Adding the Encrypt Key

Go to **Menu > Settings > Radio Set > Encrypt > Add Encrypt Key**. Then specify all the parameters of the encrypt key and press **Save**.

The following table lists the parameters of an encrypt key:

Parameter	Description
Key ID	The ID of each key must be unique. The range is 1 to 255.
Key Alias	The name of the encrypt key consists of letters, digits, special characters, and Chinese characters.
Key Length	You can select the key length as 10 characters, 32 characters or 64 characters.

Parameter	Description
Key Value	Key value consists of digits or letters. It must be shorter than the key length.

### 2. Editing the Encrypt Key

Go to **Menu > Settings > Radio Set > Encrypt > Encrypt Key List** to select the target encrypt key, and then select **Edit** to edit the key and press **Save**.

### 3. Selecting the Encrypt Key

Go to **Menu > Settings > Radio Set > Encrypt > Encrypt Key List**, and then select the target encrypt key.

- In trunking mode, you can configure the encrypt type as follows:

Go to **Menu > Settings > Radio Set > Encrypt > Encrypt Services**, and then select **Voice Only**, **Data Only** or **Voice and Data**.

## Scrambler

The Scrambler feature allows the radio to invert the frequency spectrum of transmitted audio signals. Only the receiving radio with the same scrambler setting can restore the audio signals. This prevents eavesdropping and ensures communication privacy.

To enable the feature, you can do either of the following:

- Go to **Menu > Settings > Radio Set > Scrambler > Enable**.
- Press the preprogrammed **Scrambler** key.

## Emergency Erase Data

The Emergency Erase Data feature allows the radio to erase encryption data in case of emergency, so as to prevent the data from unauthorized access. When erasing data, the radio stops voice and data services and returns to the home screen.

If this feature is enabled by your dealer, the encryption data will be deleted in the following scenario:

- After you press **PI** key + **PTT** key (Time interval of pressing the two keys is no more than 1.5s.) two times, and then press **PI** key, the radio displays "Deleted", indicating that the data is erased.
- When your radio is killed, the data will be erased automatically.

## Stun, Revive and Kill

When the radio is stunned by the trunking system, it displays "Stunned" and its services except the registration, revive, kill, and authentication will be locked out.

A stunned radio can restore to normal use when receiving the revive command from the trunking system. Then the radio displays "Revived".

When the radio is killed by the trunking system, it displays "Killed" and all its functions will be locked out, except powering on/off. To reuse a killed radio, you need to send it back to our company.

The Stun, Revive and Kill features are enabled by default, and triggered by the trunking system.

## Supplementary Features

In conventional mode, the radio supports features on digital channel and analog channel:

### Digital Channel

- **Alert Call**: allows you to send an alert call to a private call contact. The called party can call you back after seeing the alert.
- **Radio Check**: allows you to send a Radio Check command to a private call contact, so as to check whether its radio is powered on or operating on the current channel without disturbing the contact.
- **Remote Monitor**: allows you to activate the microphone of a private call contact remotely, and monitor its activities or background voice.
- **Radio Enable**: allows you to send the Radio Enable command to a private call contact to restore its radio to normal use.
- **Radio Disable**: allows you to send the Radio Disable command to a private call contact to disable its radio. Except remote monitor, all other functions of the disabled radio are locked out. The radio must be reprogrammed by the dealer for reuse or enabled by the Radio Enable command.

You can configure the features by any of the following:

- **Alert Call**: allows you to send an alert call to a private call contact. The called party can call you back after seeing the alert.

To enable the features, you can do any of the following:

- Go to **Menu > Contact > Favorites/ Contact List**, and select the required private call contact, and then select **Ctrl Services** to enable the required feature.
- Go to **Menu > Settings > Radio Set > Keypad Mode > Enable**, enter the private call contact ID, and then press the **OK/Menu** key to access **Ctrl Services** to enable the required feature.
- Press the preprogrammed **One Touch Call/Menu Key**.

### Analog Channel

- **Compressor**: allows you to compress the voice signal when transmitting and decompress the voice signal when receiving during voice communication, so as to improve the voice quality.

To enable this feature, go to **Menu > Settings > Radio Set > Compressor**.

- **Monitor**: allows you to receive more signals or weak signals, and helps you to recognize the weak voice in the speaker.

To enable this feature, press the preprogrammed **Monitor** key. Or you can press and hold down the preprogrammed **Monitor Momentary** key to enable the feature and release the key to disable the feature.

- **Squelch Off**: allows the radio to always unmute the speaker, no matter whether carrier is present or not. The Squelch Off Momentary feature allows the radio to temporarily unmute the speaker. When the Squelch Off feature is enabled, the radio sounds background noise.

To enable this feature, press the preprogrammed **Squelch Off** key. Or you can press and hold down the preprogrammed **Squelch Off Momentary** key to enable the feature and release the key to disable the feature.

- **Adjust Squelch Level**: allows you to adjust the squelch threshold required for the radio to be unmuted. Generally, the higher squelch level requires stronger signal for the radio to be unmuted. The squelch level includes Open, Normal and Tight. If you set the squelch to open level, the speaker keeps unmuted.

To switch the squelch level, go to **Menu > Settings > Radio Set > Squelch**, and select **Open, Normal** or **Tight**. Or you can press the preprogrammed **Adjust Squelch Level** key to switch the squelch level.

- **CTCSS/DCSS**: allows the radio to play the voice only when the received CTCSS/DCSS matches the transmitted CTCSS/DCSS.

To enable this feature, go to **Menu > Programming > Channel**, and set the type and value of **RX/TX CTCSS/DCSS**.

## Troubleshooting

Phenomena	Analysis	Solution
You cannot turn on the radio.	The power cord may be disconnected or not securely connected to the outlet.	Properly connect the power cord and ensure secure connection.
The radio cannot register successfully.	The radio fails to detect signals from the base station.	Make sure your radio is within the coverage of the base station.
	The validity of the radio has not been authenticated by the base station.	Contact the base station manager to check whether the radio is authorized in the network management system.
The radio registers repeatedly.	The signal is discontinuous.	Make sure your radio is within the coverage of the base station.
You cannot establish a call.	The signal is poor.	Make sure your radio is within the coverage of the base station.
You cannot hear voice after establishing a call.	Your radio ID may be repeated.	Contact the base station manager to check whether your radio ID is repeated in the network management system.
The called party disconnects repeatedly during communication.	The signal is discontinuous.	Make sure your radio is within the coverage of the base station.
You hear unclear voice.	The signal is poor.	Make sure you and other members are within the communication range.
During receiving, the voice is weak or intermittent.	The battery voltage may be low.	Recharge or replace the battery.
	The volume level may be low.	Increase the volume.
	The antenna may be loose or may be installed incorrectly.	Turn off the radio, and then remove and reattach the antenna.
	The speaker may be blocked or damaged.	Clean the surface of the speaker.
You cannot communicate with other group members.	The frequency or signaling type may be inconsistent with that of other members.	Verify that your TX/RX frequency and signaling type are correct.
	The channel type (digital or analog) may be set incorrectly.	Verify that you are on the correct digital or analog channel.
	You may be too far away from other members.	Move towards other members.
	The signal is poor.	Make sure you and other members are within the communication range.



Phenomena	Analysis	Solution
You hear unknown voice or noise.	You may be interrupted by radios using the same frequency.	Change the frequency, or adjust the squelch level.
	The radio may be set with no signaling.	Set signaling for all member radios to avoid interference at the same frequency, and make sure that all members share the same signaling.
During receiving, you hear too much noise and hiss.	The signal is poor.	Make sure you and other members are within the communication range.
	You may be in unfavourable position. For example, your communication may be blocked by high buildings or blocked in an underground area.	Move to an open an flat area, restart the radio, and try again.
	It may be the result of external disturbance (such as electromagnetic interference).	Stay away from equipment that may cause interference.
You cannot use the keys.	The keypad may not work temporarily.	Restart the radio.
The LCD does not display any information.	The LCD may not work temporarily.	Restart the radio.
The GPS cannot locate your position.	The radio may be at an unfavorable position, so that no GPS signal is received.	Move to an open and flat area, and restart GPS .

If the above solutions cannot fix your problems, or you may have some other queries, please contact your local dealer or our company for more technical support.

## Care and Cleaning

To guarantee optimal performance as well as a long service life of the product, please follow the tips below.

### Product Care

- Do not pierce or scrape the product.
- Keep the product away from substances that can corrode the circuitry.
- Do not hold the product by its antenna or earpiece cable.
- Close the accessory connector cover when no accessory is in use.

### Product Cleaning



#### CAUTION

Turn off the product and remove the battery before cleaning.

- Clean up the dust and fine particles on the product surface and charging piece with a clean and dry lint-free cloth or a brush regularly.
- Use neutral cleanser and a non-woven fabric to clean the keys, knobs, and front case after long-time use. Do not use chemical preparations such as stain removers, alcohol, sprays or oil preparations, so as to avoid potential damage on the surface.
- Make sure the product is completely dry before use.

## Optional Accessories



#### CAUTION

Use the approved accessories only; otherwise, we will not be liable for any loss or damage arising out of the use of any unauthorised accessories.

## Abbreviations

Abbreviation	Full Name
A	
AGC	Automatic Gain Control
D	
DTMF	Dual-tone Multi-frequency
F	
FOACSU	Full Off Air Call Set-Up
G	
GPS	Global Positioning System
L	
LCD	Liquid-Crystal Display
LED	Light-Emitting Diode
O	
OACSU	Off Air Call Set-Up
P	
PABX	Private Automatic Branch eXchange
PSTN	Public Switched Telephone Network
PTT	Push-To-Talk
T	
TM-DL	Trunking Mode - Digital Local
TM-DW	Trunking Mode - Digital Wide
X	
XPT	eXtended Pseudo Trunking



is the trademark or registered trademark of Hytera Communications Corporation Limited.  
© 2018 Hytera Communications Corporation Limited. All Rights Reserved.

Address: Hytera Tower, Hi-Tech Industrial Park North, 9108#Beihuan Road,  
Nanshan District, shenzhen, People's Republic of China

Postcode: 518057  
<http://www.hytera.com>