



*OWNER'S MANUAL*

MD6 X DIGITAL MOBILE RADIO





Welcome to the world of Hytera and thank you for purchasing this product. This manual includes a description of the functions and step-by-step procedures for use. It also includes a troubleshooting guide. To avoid bodily injury or property loss caused by incorrect operation, please carefully read the *Safety Information Booklet* before use.

This manual is applicable to the following product:

MD62X Digital Mobile Radio (X may represent 2, 5, 6, or 8)

## Copyright Information

Hytera is the trademark or registered trademark of Hytera Communications Corporation Limited (the Company) in the People's Republic of China (PRC) and/or other countries or areas. The Company retains the ownership of its trademarks and product names. All other trademarks and/or product names that may be used in this manual are properties of their respective owners.

The product described in this manual may include the Company's computer programs stored in memory or other media. Laws in PRC and/or other countries or areas protect the exclusive rights of the Company with respect to its computer programs. The purchase of this product shall not be deemed to grant, either directly or by implication, any rights to the purchaser regarding the Company's computer programs. The Company's computer programs may not be copied, modified, distributed, decompiled, or reverse-engineered in any manner without the prior written consent of the Company.

## Disclaimer

The Company endeavors to achieve the accuracy and completeness of this manual, but no warranty of accuracy or reliability is given. All the specifications and designs are subject to change without notice due to continuous technological development. No part of this manual may be copied, modified, translated, or distributed in any manner without the prior written consent of the Company.

We do not guarantee, for any particular purpose, the accuracy, validity, timeliness, legitimacy or completeness of the third-party products and contents involved in this manual.

If you have any suggestions or would like to receive more information, please visit our website at <http://www.hytera.com>.

## FCC Statement

This equipment has been tested and found to comply with the limits for a Class B digital device, pursuant to part 15 of FCC Rules. These limits are designed to provide reasonable protection against harmful interference in a residential installation. This equipment generates and can radiate radio frequency energy. If not installed and used in accordance with the instructions, it may cause harmful interference to radio communications. However, there is no guarantee that interference will not occur in a particular installation. Verification of harmful interference by this equipment to radio or television reception can be determined by turning it off and then on. The user is encouraged to try to correct the interference by one or more of the following measures:

- Reorient or relocate the receiving antenna. Increase the separation between the equipment and receiver.
- Connect the equipment into an outlet on a different circuit to that of the receiver's outlet.
- Consult the dealer or an experienced radio/TV technician for help.

Operation is subject to the following two conditions:

- This device may not cause harmful interference.
- This device must accept any interference received, including interference that may cause undesired operation.

Note: Changes or modifications to this unit not expressly approved by the party responsible for compliance could void the user's authority to operate the equipment.

## Compliance with RF Exposure Standards

The radio complies with the following RF energy exposure standards and guidelines:

- United States Federal Communications Commission, Code of Federal Regulations; 47 CFR § 1.1307, 1.1310 and 2.1093
- American National Standards Institute (ANSI)/Institute of Electrical and Electronic Engineers (IEEE) C95.1:2005; Canada RSS102 Issue 5 March 2015
- Institute of Electrical and Electronic Engineers (IEEE) C95.1:2005 Edition

## RF Exposure Compliance and Control Guidelines and Operating Instructions

To control your exposure and ensure compliance with the occupational/controlled environmental exposure limits, always adhere to the following procedures.

Guidelines:

- Do not remove the RF Exposure Label from the device.
- User awareness instructions should accompany device when transferred to other users.
- Do not use this device if the operational requirements described herein are not met.

Operating Instructions:

- Transmit no more than the rated duty factor of 50% of the time. To transmit (talk), press the **Push-to-Talk (PTT)** key. To receive calls, release the **PTT** key. Transmitting 50% of the time, or less, is important because the radio generates measurable RF energy only when transmitting (in terms of measuring for standards compliance).
- Keep the radio unit at least 2.5 cm away from the face. Keeping the radio at the proper distance is important as RF exposure decreases with distance from the antenna. The antenna should be kept away from the face and eyes.
- When worn on the body, always place the radio in an approved holder, holster, case, or body harness or by use of the correct clip for this product. Use of non-approved accessories may result in exposure levels which exceed the FCC's occupational/controlled environmental RF exposure limits.
- Use of non-approved antennas, batteries, and accessories causes the radio to exceed the FCC RF exposure guidelines.
- Contact your local dealer for the product's optional accessories.

## IC Statement

The device has been tested and complies with SAR limits, users can obtain Canadian information on RF exposure and compliance.

Après examen de ce matériel aux conformités aux limites DAS et/ou aux limites d'intensité de champ RF, les utilisateurs peuvent sur l'exposition aux radiofréquences et la conformité et compliance d'acquérir les informations correspondantes

This device complies with Industry Canada license-exempt RSS standard(s). Operation is subject to the following two conditions:

- This device may not cause harmful interference.
- This device must accept any interference received, including interference that may cause undesired operation.

Le présent appareil est conforme aux CNR d'Industrie Canada applicables aux appareils radio exempts de licence. L'exploitation est autorisée aux deux conditions suivantes: (1) l'appareil ne doit pas produire de brouillage, et (2) l'utilisateur de l'appareil doit accepter tout brouillage radioélectrique subi, même si le brouillage est susceptible d'en compromettre le fonctionnement

## EU Regulatory Conformance

As certified by the qualified laboratory, the product is in compliance with the essential requirements and other relevant provisions of , 2011/65/EU, 2012/19/EU, and 2014/53/EU.

Please note that the above information is applicable to EU countries only.



# Contents

---

<b>Contents</b> .....	1	Sending Messages .....	6
<b>Documentation Conventions</b> .....	2	Deleting Messages .....	6
<b>Packing List</b> .....	2	<b>Supplementary Features</b> .....	6
<b>Product Overview</b> .....	2	Basic Settings .....	6
Product Layout .....	2	Contact Management .....	7
Programmable Keys .....	3	Scan .....	7
<b>Installation</b> .....	3	Time-out Timer .....	7
Instructions .....	3	Busy Channel Lockout .....	7
Tools .....	3	Talk Around .....	7
Parts .....	3	One Touch Call .....	7
Procedure .....	4	Public Address .....	8
<b>Basic Operations</b> .....	4	Ignition Sense .....	8
Turning the Radio On or Off .....	4	Priority Interrupt .....	8
Adjusting the Volume .....	4	Emergency Feature .....	8
Selecting a Zone and Channel .....	4	Positioning Service .....	9
<b>Status Indications</b> .....	4	BT Service .....	9
Checking LCD Indications .....	4	Digital Services .....	10
Checking LED Indications .....	5	Analog Features .....	10
<b>Call Services</b> .....	5	<b>Troubleshooting</b> .....	12
Call on Digital Channel .....	5	<b>Care and Cleaning</b> .....	14
Call on Analog Channel .....	6	Product Care .....	14
<b>Message Services</b> .....	6	Product Cleaning .....	14
Viewing Messages .....	6	<b>Optional Accessories</b> .....	14
		<b>Abbreviations</b> .....	14

## Documentation Conventions

### Icon Conventions

Icon	Description
 <b>Note</b>	Indicates references that can further describe the related topics.
 <b>Caution</b>	Indicates situations that could cause data loss or equipment damage.

### Notation Conventions

Item	Description	Example
<b>Boldface</b>	Denotes menus, tabs, parameter names, window names, dialogue names, and hardware buttons.	To save the configuration, click <b>Apply</b> . The <b>Log Level Settings</b> dialogue appears. Press the <b>PTT</b> key.
" "	Denotes messages, directories, file names, folder names, and parameter values.	The screen displays "Invalid Battery!". Open "PDT_PSS.exe". Go to "D:/opt/local". In the <b>Port</b> text box, enter "22".
>	Directs you to access a multi-level menu.	Go to <b>File &gt; New</b> .
<i>Italic</i>	Denotes document titles.	For details about using the DWS, refer to <i>Dispatch Workstation User Guide</i> .
Courier	Denotes	To set the IP address, run

Item	Description	Example
New	commands and their execution results.	the following command: vos-cmd - m name IP

### Packing List

Please unpack carefully and check that you have received the following items. If any item is missing or damaged, please contact your dealer.

Item	Quantity (PCS)	Item	Quantity (PCS)
Mobile Radio	1	Palm Microphone	1
Mounting Bracket	1	Microphone Hanger	1
Locking Knob	2	Screw (4 mm x 16 mm)	3
Screw (4.8 mm x 20 mm)	4	Power Cord (with fuse)	1
Documentation Kit	1	/	/

#### Note

Check whether the frequency band marked on the antenna label matches that on the radio label. If not, please contact your dealer.

## Product Overview

### Product Layout

#### Mobile Radio

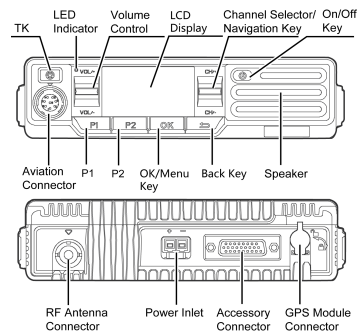

#### Note

The GPS module connector is used only when the mobile radio has the GPS module.

## Palm Microphone

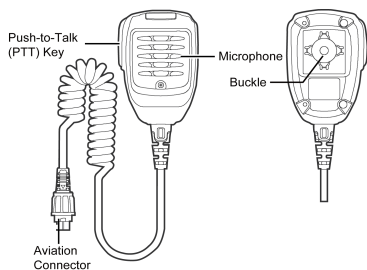

antenna and power cord authorized by the Company only.

- Install the radio with the mounting bracket supplied by the Company to avoid radio looseness in case of accidents. The loose radio may cause bodily injury.
- Install the radio in a location where you can reach the front panel conveniently.
- Keep sufficient clearance at the back of the radio for wiring.
- Be sure to use the fuse with the same specification for the DC power cord upon replacement.
- Ensure the antenna of the radio must be no less than 10 meters away from that of other RF devices.

## Programmable Keys

You can request your dealer to program **TK**, **P1** key, and **P2** key as shortcuts to assignable radio features.

## Installation

### Instructions

Before installing the radio in a vehicle, read the following instructions carefully:

- The radio must work with a  $13.6V \pm 15\%$  negative ground electrical system only. Ensure to check the polarity and voltage of the vehicle power supply.
- Check how long the screws will extend from the bottom surface of the radio. Drill the mounting hole cautiously to avoid damage to the vehicle wiring and other parts.
- Connect the antenna and power cord to the radio before you install the radio in the bracket. Use the

### Tools

- Electric drill
- Cross head screwdriver
- T20 torx screwdriver

## Parts

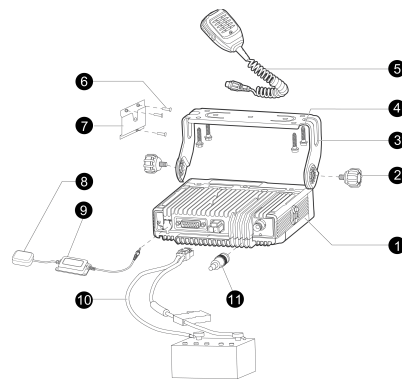

NO.	Part Name	NO.	Part Name
1	Mobile Radio	7	Microphone Hanger
2	Locking Knob	8	GPS Antenna
3	Mounting Bracket	9	GPS Module
4	Screw (4.8 mm x 20 mm)	10	Power Cord (with fuse)
5	Palm Microphone	11	RF Antenna
6	Screw (4 mm x 16 mm)	12	/

## Note

The RF antenna, GPS antenna, and GPS module should be purchased separately.

## Procedure

1. Select a location, drill holes based on the shape of the mounting bracket, and then use the screws (4.8 mm x 20 mm) to secure the bracket.
2. Connect the RF antenna, GPS antenna, GPS module, and power cord to the radio.
3. Slide the radio into the mounted bracket and secure it using the locking knobs.
4. Install the microphone hanger in a location where you can reach it easily, and use the screws (4 mm x 16 mm) to secure it.
5. Align the triangle index on the palm microphone with the microphone installation index, plug the connector into the radio, and rotate the connector clockwise to secure it.
6. Place the palm microphone on the hanger when you do not use it.

## Basic Operations

### Turning the Radio On or Off

To turn the radio on or off, long press the **On-Off** key.

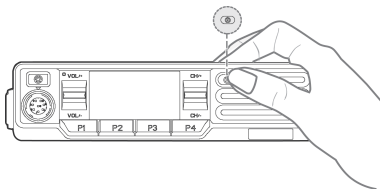

### Adjusting the Volume

To increase or decrease the volume, press the **VOL/+** or **VOL/-** key.

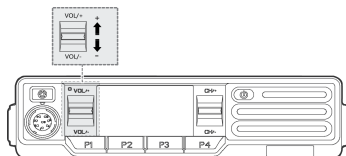

### Selecting a Zone and Channel

A channel is used to receive and transmit data and voice. A zone is a group of channels within the same operational area. The radio supports up to three zones, each of which contains up to 16 channels.





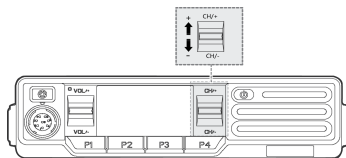





To receive and transmit data and voice, do as follows:

1. Use either of the following ways to select a zone.
  - Select **Zone**, and then select the required zone.
  - Press the preprogrammed **Zone Up** or **Zone Down** key.
2. Press the **CH/+** or **CH/-** key to select a channel.















## Status Indications

### Checking LCD Indications

Icon	Radio Status
<b>DM</b>	Direct Mode: The radio transmits and receives directly.
<b>TDMA</b>	TDMA Direct Mode: If one time slot is occupied, the radio transmits and receives through the other time slot.
<b>RM</b>	Repeater Mode: The radio transmits and receives through a repeater.
	There is no signal.
	The number of bars indicates the signal strength.
	The radio operates in low power mode.
	The radio operates in high power mode.
	The radio is in emergency mode.
	The radio is roaming.
	The Scrambler or Encrypt feature is enabled.
	The radio is scanning.
	The radio stays on a non-priority channel.
	The radio stays on priority channel 1.



Icon	Radio Status
	The radio stays on priority channel 2.
	The Monitor feature is enabled.
	The speaker is turned on.
	The Global Positioning System (GPS) feature is enabled, and the radio receives GPS data.
	The GPS feature is enabled, but the radio receives no GPS data.
	The BT feature is enabled.
	The radio is connected to a BT device.
	There is/are missed call(s).
	There is/are unread short message(s).
	The Inbox is full.
	<ul style="list-style-type: none"> <li>• An ongoing private call.</li> <li>• A private contact on the contact list.</li> </ul>
	<ul style="list-style-type: none"> <li>• An ongoing group call.</li> <li>• A group contact on the contact list.</li> </ul>
	<ul style="list-style-type: none"> <li>• An ongoing all call.</li> <li>• An all call contact on the contact list.</li> </ul>

#### Note

GPS and BT icons are available only to radios with GPS and BT features.

## Checking LED Indications

LED Indicator	Radio Status
Flashes green	Being turned on.
Glowes green	Receiving.
Glowes red	Transmitting.
Flashes orange slowly	Scanning or roaming.
Flashes orange rapidly	Operating in emergency mode.
Glowes orange	Call hang time: No voice is being transmitted or received on the channel during a call. Within such a period, you can press and hold the <b>PTT</b> key and speak.

## Call Services

When you are speaking during a call, keep the microphone about 2.5 to 5 cm away from your mouth. This ensures optimal voice quality on the receiving radio.

## Call on Digital Channel

You can initiate or receive the following types of calls on a digital channel:

- Private call: a call from an individual user to another individual user.

- Group call: a call from an individual user in a group to all the other members in the group.
- All call: a call from an individual user to all the other users on the current channel.

#### Note



The All Call feature must be authorized by your dealer.

## Initiating Calls

To initiate a call, do one of the following:

- To initiate a call to the private contact, group contact, or all call contact preset for the current channel, press and hold the **PTT** key.
- To initiate a call to a private contact, group contact or all call contact preset for a non-current channel, press the **CH/+** or **CH/-** key to select the channel, and then press and hold the **PTT** key.
- Go to **Contact > Contacts/Favorites**, select the required contact, and press and hold the **PTT** key.
- Go to **Call Logs > Outgoing/Incoming/Missed > Outgoing List/Incoming List/Missed List**, select the required private contact, and press and hold the **PTT** key.
- Press the preprogrammed **One Touch Call** key to initiate a call to the preset private or group contact.

#### Note



The icon , , or  appears on the LCD display when the radio initiates a private call, group call, or all call.

## Receiving and Responding to Calls

When receiving a call, you can listen to it without any operation.

You can press and hold the **PTT** key and speak within call hang time.

#### Note

The icon , , or  appears on the LCD display when the radio receives a private call, group call, or all call.

## Ending Calls

- A group or private call ends when the call hang time expires.
- An all call ends when the calling party releases the **PTT** key.

## Call on Analog Channel

You can initiate or receive a call on an analog channel with or without signaling.

### Call Without Signaling

On an analog channel without signaling, you can initiate a call to all the other users on the channel. Do as follows:

1. Press the **CH/+** or **CH/-** key to select the required channel.
2. Press and hold the **PTT** key.

### Call With Signaling

On an analog channel with signaling, you can initiate a call to a specific contact on the channel. Do as follows:

1. Press the **CH/+** or **CH/-** key to select the required channel.

2. Press the **PTT** key to send the code.

The call is established when the target radio receives and decodes the matched signaling.

## Message Services

The Message feature allows you to view and forward messages, and send quick text messages.

### Viewing Messages

To view a message upon receiving, directly press the **OK/Menu** key.

To view a message from the Inbox or a sent message, go to **Message > Inbox/Outbox**, and then select the required message.

## Sending Messages

### Sending Quick Text Messages

A quick text message is a frequently used message predefined by your dealer. To send a quick text message, do as follows:

1. Go to **Message > Quick Text**, and then select the required quick text message.
2. Select **Send**, and then select the required contact.
3. Press the **OK/Menu** key.

### Forwarding Messages

1. Go to **Message > Inbox/Outbox**, and then select the required message.
2. Select **Forward**, and then select the required contact.
3. Press the **OK/Menu** key.

## Resending Messages

To resend a message, go to **Message > Inbox**, select the required message, and then Press the **OK/Menu** key.

## Deleting Messages

1. Go to **Message > Inbox/Outbox**, and then select the required message.
2. Select **Delete**.
3. Press the **OK/Menu** key.

## Supplementary Features

### Basic Settings

You can go to **Settings > Radio Set** and then set the following items:

Item	Description	Operation
Power Level	Sets the TX power level of the current channel.	Select <b>Power Level</b> , and then select either of the following: <ul style="list-style-type: none"><li>● <b>High Power</b> : Enables long-distance communication but consumes more battery power.</li><li>● <b>Low Power</b> : Enables short-distance communication</li></ul>

Item	Description	Operation
		and saves battery power.
LED	Sets whether the LED indicator flashes or glows to indicate the radio status.	Select <b>LED</b> , and then select <b>On</b> or <b>Off</b> .
Tone	Sets whether the radio emits tones to indicate its status.	Select <b>Tone</b> to set required tones and volume.
Lone Worker	Allows the radio to enter the emergency mode when no operation is detected for a preset period.	Select <b>Lone Worker</b> , and then select <b>On</b> or <b>Off</b> .
Horn & Lights	Allows the radio to alarm via the external alarm devices (speaker or light), if the radio receives an emergency alert, an alert call or a private call and no key operation is made for a preset period.	Select <b>Horn &amp; Lights</b> , and then select <b>On</b> or <b>Off</b> .

## Contact Management

Contact management allows you to manage contacts.

To access all contacts, go to **Contact -> Contacts**, where you can view the details of each contact.





To access the frequently used contacts, go to **Contact -> Favorites**, where you can remove contacts from or add contacts to the favorites.

## Scan

The Scan feature allows you to listen to activities on a channel, keeping a track of your team members. With this feature enabled, the radio searches the scan list preset for the current channel and stays on an active channel.

To turn the Scan feature on or off, press the preprogrammed **Scan** key, or go to **Scan > Scan On/Off**.

To select a scan list, go to **Scan > Scan List**. The radio scans all the channels on the scan list. The radio supports up to eight scan lists, each containing up to 16 digital or analog channels.

During scanning, the LCD displays , and the LED indicator flashes yellow slowly. When it stays on an active channel, the LED indicator glows green. When it stays on a non-priority channel, the LCD displays . When it stays on priority channel 1 or 2, the LCD displays  or .

## Time-out Timer

The Time-out Timer (TOT) feature allows the radio to automatically stop transmission and keep beeping when the period preset by your dealer expires. To stop beeping, release the **PTT** key. You need to wait for a certain period (also preset by your dealer) to initiate transmission again.

This feature aims to prevent a radio user from occupying a channel for an extended period. It also avoids potential damage caused by overheating.

## Busy Channel Lockout

The Busy Channel Lockout feature prevents you from talking on a channel that is already in use. The radio keeps beeping if you press and hold **PTT** key when the current channel is occupied by other radios.

This feature aims to prevent interference from other radios on the same channel during transmission.

## Talk Around

The Talk Around feature allows your radio to continue transmitting and receiving when the repeater is not operating, or when your radio is out of the repeater's coverage but within other radio's coverage.

To turn this feature on or off, press the preprogrammed **Talk Around** key.

## One Touch Call

The One Touch Call/Menu feature allows you to press the preprogrammed **One Touch Call** key to quickly access a service assigned by your dealer. The services available for assignment are as follows:

Service Type	Description
Voice service on analog channel	Analog call
Voice and data service on digital channel	<ul style="list-style-type: none"> <li>Group call or quick text message to a group contact.</li> </ul>

Service Type	Description
	<ul style="list-style-type: none"> <li>Private call, quick text message, or control services to a private contact.</li> </ul> <p>Note:</p> <p>» To initiate a one touch call on the digital channel, press the preprogrammed <b>One Touch Call</b> key, and then press the <b>PTT</b> key.</p> <p>» For details on control services, see "Control Services" on page 10.</p>

## Public Address

Public Address allows you to address a large public via the external speaker. With this feature enabled, your voice will be output via the external speaker if you hold down the **PTT** key and speak.

To address a large public, press the preprogrammed **Public Address** key, and then hold down the **PTT** key and speak.

## Ignition Sense

The following functions can be realized by the vehicle ignition. You may request your dealer to assign any one to the radio.

Type	Description	Operation
Ignition or Switch	Allows you to turn the radio on or off by following the ignition sense or	<ul style="list-style-type: none"> <li>Start the engine to turn the radio on; the radio turns off when the engine</li> </ul>

Type	Description	Operation
	pressing the <b>On-Off</b> key.	<p>stops.</p> <ul style="list-style-type: none"> <li>Long press the <b>On-Off</b> key to turn the radio on; press the <b>On-Off</b> key to turn it off.</li> </ul>
Ignition Only	Allows you to turn the radio on and off by following the ignition sense only. In this case, the <b>On-Off</b> key does not work.	Start the vehicle engine to turn the radio on; the radio turns off when the engine stops.
PTT Disable	Allows you to enable or disable the <b>PTT</b> key by following the ignition sense.	Start the engine to enable the <b>PTT</b> key; the <b>PTT</b> key is disabled when the engine stops.
Disable Ignition Off	Allows you to turn the radio on by following the ignition sense or pressing the <b>On-Off</b> key, and allows you to turn it off only by pressing the <b>On-Off</b> key.	<ul style="list-style-type: none"> <li>Start the engine or press the <b>On-Off</b> key to turn the radio on.</li> <li>Press the <b>On-Off</b> key to turn the radio off.</li> </ul>

## Priority Interrupt

Priority Interrupt allows you to terminate the ongoing activities (such as a call, a call hang status or remote monitor) on the current channel to free the channel, so as to make a new call or a new service.

This feature supports three types of interruptions as follows:

- Message Priority Interrupt: Allows you to send a message to interrupt the active call on the current channel immediately.
- All Call Priority Interrupt: Allows you to initiate an all call to interrupt the active call on the current channel immediately.
- Radio Disable Priority Interrupt: Allows you to send a Radio Disable command to interrupt the active call on the current channel immediately.

### Note

This is a paid feature. Consult your dealer for details.

## Emergency Feature

The Emergency feature allows you to ask for help from your companion or the control center in case of emergency.

In emergency mode, the radio gives different indications according to the preset emergency type. The available emergency types are as follows:

Emergency Type	Description
Siren Only	The radio sounds shrill alarm tones and displays $\Delta$ . The alarm will not be

Emergency Type	Description
	sent to the control center.
Regular	The radio gives audible and visible indications.
Silent	The radio gives no audible or visible indication.
Silent w/ Voice	The radio gives audible indication only for an incoming call.
Alarm w/ Siren	The radio sounds shrill alarm tones and displays $\Delta$ . The alarm will be sent to the control center.

In addition, you can request your dealer to set one of the following emergency modes:

Emergency Mode	Description
Alarm	Allows you to send an emergency alarm.
Call Only	Allows you to initiate an emergency call.
Alarm W/Call	Allows you to send an emergency alarm and initiate an emergency call.

The three emergency modes can be combined with any of the following emergency types: **Regular**, **Silent**, and **Siren w/ Voice**.

## Triggering the Emergency Mode

To trigger the emergency mode, press the preprogrammed **Emergency On** key. The radio then

enters the preset emergency mode with or without indications depending on the preset emergency type.

If the Call to Follow feature is enabled by your dealer, the radio will transmit automatically. You can directly speak into the microphone in the preset period.

## Receiving an Emergency Call

You can listen to a received emergency call without any operation.

## Exiting the Emergency Mode

To exit the emergency mode (as the initiating party) or emergency alert mode (as the receiving party), press the preprogrammed **Emergency Off** key, switch the channel, or turn off the radio.

## Positioning Service

The positioning service allows the radio to acquire real-time location and time information.

## Enabling Positioning Feature

To enable this feature, do either of the following:

- Go to **Accessory** -> **GNSS** -> **GNSS Switch**, and select **On**.
- Press the preprogrammed **GPS Switch** key.

## Reporting Location

GPS Report allows the radio to transmit its location to the system.

- Manual Report

You can press the preprogrammed **GPS Report** key to report the radio's location information manually.

- Auto Report

The radio reports its location information automatically upon power on or off, or at preset interval or distance, as programmed by your dealer.

## BT Service

### Caution

- To derive optimal communication quality, use the wireless devices specified by the Company. For detailed functions and operations of the devices, refer to the corresponding user manuals.
- Any wireless earpiece manufactured by a third-party company must be used with the wireless ring PTT supplied by the Company; otherwise, the radio cannot transmit audio signals via the earpiece.

The BT feature allows the radio to exchange data with another BT-enable device over short distances (generally within 10 meters).

To perform the pairing and connection, do as follows.

1. Enable the BT feature of the radio through either of the following ways:
  - » Go to **Accessory** > **Bluetooth** > **BT Switch**, and select **On**.
  - » Press the programmed **BT** key.
2. Make the wireless device enter the pairing mode. For the detailed operations, refer to the corresponding user manual.
3. Go to **Accessory** -> **Bluetooth** -> **Device Search**, and select **Search PTT** or **Search Earphone**.

4. On the **Devices List**, select the wireless device found and then select **Connect**.

When the radio displays the prompt “Connect Success”, the wireless connection has been established.

For a better audio clarity, put the radio at most two meters away from the wireless devices, with the radio’s front panel towards the devices.

## Digital Services

### Encrypt

The Encrypt feature allows the radio to automatically encrypt transmitted voice or data. Only the receiving radio with the same key value or ID can decrypt the voice or data. This prevents eavesdropping and ensures communication privacy.

To turn this feature on or off, press the preprogrammed **Encrypt** key.

### TDMA Direct Mode

TDMA Direct Mode allows the radio to transmit and receive through the other time slot if one time slot is occupied.

When the radio is in TDMA Direct Mode, the LCD displays "TDMA".

You can request your dealer to enable this mode.

### Extended Pseudo Trunk (XPT)

XPT allows the radio to transmit and receive over the available slot in the TDMA direct mode or repeat mode. This optimizes the use of channel resources and

minimizes the potential interference with other ongoing calls.

You can request your dealer to enable this feature.

### Roam

The Roam feature allows you to enjoy seamless communication across sites.



#### Note

This is a paid feature. For details, contact your dealer.

### Control Services

On the digital channel in conventional mode, you can initiate the following control services to a private contact.

Feature	Description	Operation
Alert Call	Allows you to alert a private contact to call you back.	To trigger the corresponding feature, do as follows: <ol style="list-style-type: none"> <li>1. Go to <b>Contact &gt; Favorites / Contacts</b>.</li> <li>2. Select the required private contact.</li> <li>3. Go to <b>Ctrl Services &gt; Alert Call / Radio Check / R.Monitor / Radio Enable / Radio Disable</b>.</li> </ol>
Radio Check	Allows you to check whether another radio is operating on the current channel without disturbing that radio user.	
Remote Monitor	Allows you to remotely monitor activities surrounding another radio.	

Feature	Description	Operation
Revive	Allows you to remotely enable a disabled radio for normal operation.	
Kill	Allows you to remotely disable a radio.	



#### Note

The Remote Monitor, Radio Enable, and Radio Disable are paid features. For details, contact your dealer.

## Analog Features

### Scrambler

The Scrambler feature allows the radio to invert the frequency spectrum of transmitted audio signals. Only the receiving radio with the same scrambler setting can restore the audio signals. This prevents eavesdropping and ensures communication privacy.

To turn this feature on or off, go to **Settings -> Radio Set -> Scrambler**, or press the preprogrammed **Scramble** key.

### Monitor

The Monitor feature allows the radio to receive weak signals.

To turn this feature on or off, press the preprogrammed **Monitor** key.

## Squelch Off

The Squelch Off feature allows the radio's speaker to keep turned on no matter whether the squelch condition is satisfied.

To turn this feature on or off, press the preprogrammed **Squelch Off** key.

## Squelch Level

The squelch level refers to the squelch threshold required for the radio's speaker to be turned on.

To adjust the squelch level, go to **Settings -> Radio Set -> Squelch Level**, or press the preprogrammed **Adjust Squelch Level** key. The radio switches among three levels, i.e. Open, Normal, and Tight (from low to high). Generally, a higher squelch level requires higher signal strength. If the squelch level is set to Open, the speaker will always keep turned on.

## CTCSS/CDCSS

The Continuous Tone- Coded Squelch System (CTCSS)/Continuous Digital- Coded Squelch System (CDCSS) feature allows the radio to filter out unwanted voice on the current channel. With this feature enabled, the radio's speaker is turned on only when the CTCSS/CDCSS code received matches the CTCSS/CDCSS code set for the radio.

You can request your dealer to enable this feature.

## Troubleshooting

Phenomena	Analysis	Solution
You cannot turn the radio on.	The power cord may be disconnected or not securely connected to the outlet.	Properly connect the power cord and ensure secure connection.
During receiving, the voice is weak or intermittent.	The volume level may be low.	Increase the volume.
	The antenna may be loose or may be installed incorrectly.	Turn the radio off, and then remove and reattach the antenna.
	The speaker may be blocked.	Clean the surface of the speaker.
You cannot communicate with other group members.	The frequency or signaling type may be inconsistent with that of other members.	Verify that your TX/RX frequency and signaling type are correct.
	The channel type (digital or analog) may be set incorrectly.	Verify that you are on the correct digital or analog channel.
	You may be too far away from other members.	Move towards other members.
You hear unknown voices or noise.	You may be interrupted by radios using the same frequency.	Change the frequency, or adjust the squelch level.
	The radio in analog mode may be set with no signaling.	Request your dealer to set signaling for the current channel to avoid interference.
You are unable to hear anyone because of too much noise and hiss.	You may be too far away from other members.	Move towards other members.
	You may be in an unfavourable position. For example, your communication may be blocked by high buildings or blocked in an underground area.	Move to an open and flat area, restart the radio, and try again.
	It may be the result of external disturbance (such as electromagnetic interference).	Stay away from equipment that may cause interference.
You cannot use the keys.	The keypad may not work temporarily.	Restart the radio.
The LCD does not display any information.	The LCD may not work temporarily.	Restart the radio.
The speaker of the receiving radio outputs abnormal voice.	The palm microphone of the transmitting radio is not connected properly.	Remove and reattach the palm microphone.



Phenomena	Analysis	Solution
The GPS does not work.	The GPS module is not connected properly.	Properly connect the GPS module.
	You may be in an unfavourable position where the GPS signal is too weak to receive.	Move to an open and flat area, restart the radio, and try again.
The radio fails to pair with the wireless device.	The wireless device is at low battery level.	Charge the wireless device.
	The wireless device is too far away from the radio.	Move the wireless device towards the radio.

If the above solutions cannot fix your problems, or you may have some other queries, please contact your dealer for more technical support.

## Care and Cleaning

To guarantee optimal performance as well as a long service life of the product, please follow these tips.

### Product Care

- Do not pierce or scrape the product.
- Keep the product far away from substances that can corrode the circuitry.
- Do not hold the product by the antenna or earpiece cable.
- Close the accessory connector cover when no accessory is in use.

### Product Cleaning



#### Caution

Turn off the product and remove the battery before cleaning.

- Clean up the dust and fine particles on the product surface and charging piece with a clean and dry lint-free cloth or a brush regularly.
- Use neutral cleanser and a non-woven fabric to clean the keys, knobs, and front case after long-time use. Do not use chemical preparations such as stain removers, alcohol, sprays or oil preparations, so as to avoid surface case damage.
- Make sure the product is completely dry before use.

## Optional Accessories

Contact your local dealer for the optional accessories used with the product.

#### Caution

Use the approved accessories only; otherwise, we will not be liable for any loss or damage arising out of the use of any unauthorised accessories.

## Abbreviations

Abbreviation	Full Name
DTMF	Dual-tone Multi-frequency
GPS	Global Positioning System
LCD	Liquid-Crystal Display
LED	Light-Emitting diode
PTT	Push-to-Talk
TDMA	Time Division Multiple Access



is the trademark or registered trademark of Hytera Communications Corporation Limited.  
© 2017 Hytera Communications Corporation Limited. All Rights Reserved.

Address: Hytera Tower, Hi-Tech Industrial Park North, 9108#Beihuan Road,  
Nanshan District, shenzhen, People's Republic of China

Postcode: 518057  
<http://www.hytera.com>