

# 80m and 40m Dual-band Vertical Antenna

## CP8040

### Operation Instructions

#### •Description

- ①The CP8040 is a dual-band vertical antenna for HF low band.
- ②Compact, light weighted and very easy to assemble.
- ③It is completely self-supported and does not need any guy wires.
- ④Trap radials could be concentrated on one direction instead of spreading them around the antenna. This is especially convenient if the antenna is installed on balcony railing or window side of condominiums and urban apartments.
- ⑤Since the antenna is direct DC ground at the feed point, coaxial cable and transceiver are being protected from the high voltage caused by lightning.
- ⑥Center frequencies of the antenna are adjustable in each band simply by change radial length and capacity hat (80m only).
- ⑦Top loading structure utilizing capacitive hat enables the antenna to complete with full quarter wave length antennas in its performance.
- ⑧It is rigid and rugged enough to withstand the wind pressure over 35m/sec.
- ⑨Mast brackets area adjustable to accept 1 1/5" to 2 1/3" diameter mast.
- ⑩Since feeding point is covered by the support pipe, it is excellent in the waterproof property.
- ⑪CP8040 can be used 3.5-3.8MHz / 7-7.2MHz.

#### •Parts Description

Parts #	Description	Qty
M45001	Pipe No. 1 $\phi$ 7.4	1
M45002	Pipe No. 2 $\phi$ 10	1
M45003	Pipe No. 3 $\phi$ 30	1
M45004	Pipe No. 4 $\phi$ 30	1
M45005	Pipe No. 5 $\phi$ 30	1
M45006	S trap	1
M45007	Loading coil for 7MHz	1
M45008	Hat	2
M45009	Hat S	4
M45010	Hat SS	4
M45011	Hat ring	1
M45012	Feeding point assembly	1
M45013	Radial ring	1
M45014	Support pipe	1
M45015	Radial coil for 3.5MHz	1
M45016	Radial coil for 7MHz	1
M45017	Radial element	2
M45018	Tension ring	2
M45019	Mast bracket	2
M45020	V-volt set	2
M45021	Tapping screw M4x8	12
M45022	Inner tooth washer M4	12
M45023	Hex head screw M6x8	3
M45024	Spring washer M6	3
M45025	Radial nut	2

#### •Parts Description

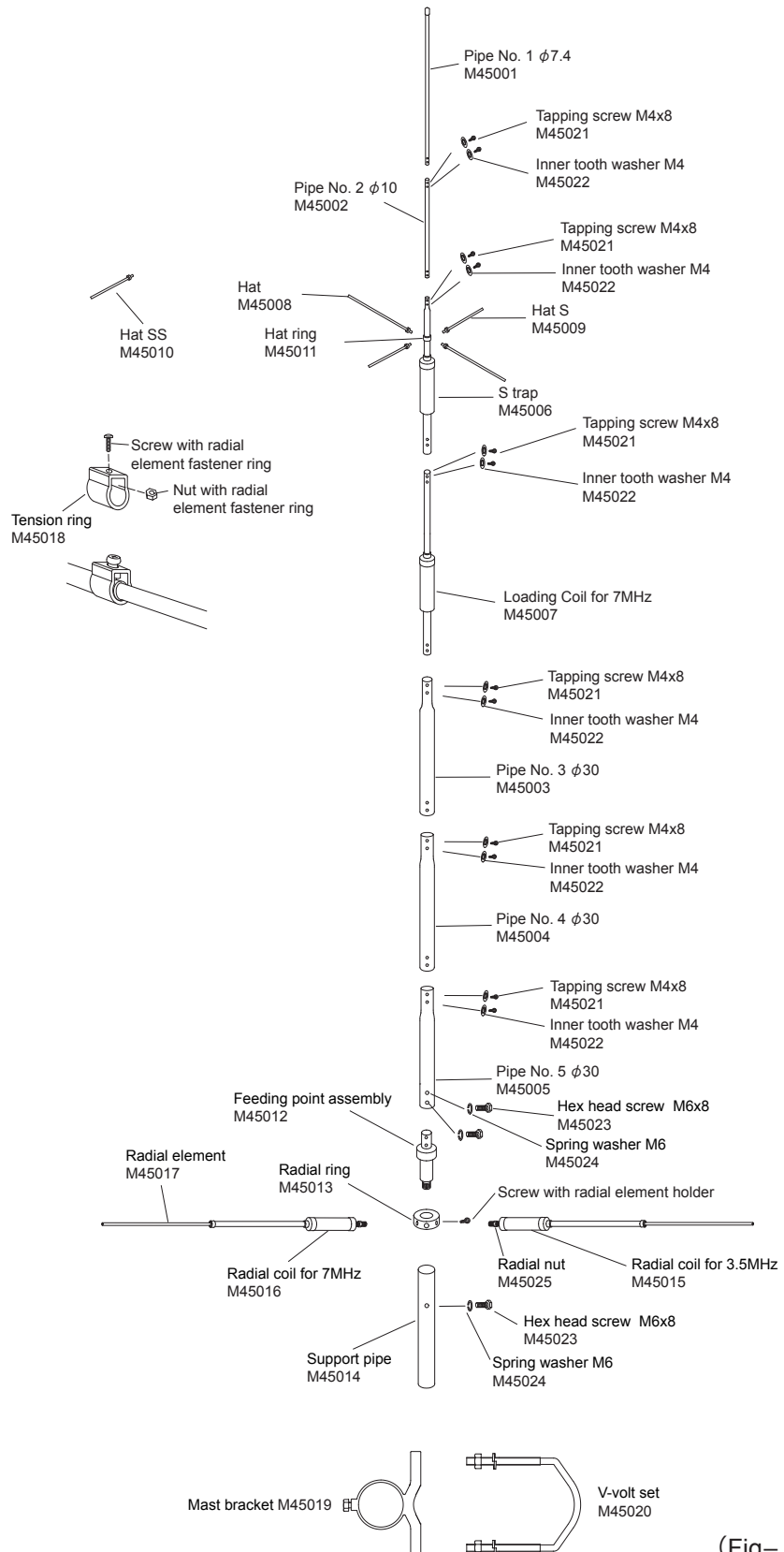

(Fig-1)



-Note-----

<<Installing the antenna>>

- ① Don't install on a rainy or windy day since it is dangerous.
- ② Don't attempt to install the antenna only by yourself. Installing the antenna alone on the roof may lead you dangerous accident. Always ask your friends for help installing the antenna.
- ③ Don't drop the antenna, tools and attachment when installing the antenna in the height. Install the antenna before assembling it on the ground.

<<Antenna location>>

- ① If the CP8040 is located on the roof of a house or top of a building, look around the roof to see if there are any obstacles such as an electronic wire or TV antenna. The CP8040 has to be located as far away as possible from those things to obtain its maximum performance. Installing the antenna too close to the building wall may cause bad effect for electrical characteristics of the antenna.
- ② Don't install the antenna where is easily reachable by people.
- ③ Install the antenna firmly not to fall down due to the strong wind. Even if falling down the antenna, locate the antenna at the safe place where people and building are not inflicted injures.

<<Before transmitting>>

- ① Transmit after confirming if the antenna works normally by an SWR meter. If VSWR is less than 1.5, it is no problem. If VSWR is higher, stop transmitting and check if the parts of the antenna and coaxial cable are connected. If there are tall buildings or obstacles or the distance between the antenna and the ground is short, VSWR may not be lowered.

※Diamond Antenna SWR/POWER meter is an insertion type being connected between a transmitter and an antenna. Transmitting power and SWR can be measured with very simple operations. In addition with those conventional measurements, PEP (peak envelope power) on SSB mode can be measured with a PEP monitor function. With our Diamond's wideband and low insertion loss directional coupler those measurements can be performed with minimum effect in transmission line.

<<During transmitting>>

- ① Touching the antenna during transmission may cause to electrify. Pay attention not to touch the antenna especially for children if installing on a balcony railing.

<<Rumbling Thunder>>

- ① The thunder seems to rumble in the vicinity, don't touch the antenna and coaxial. When you don't use the radio, take off the cable from the radio.

<<If there is something wrong, stop transmitting immediately>>

- ① Keeping transmitting with high VSWR may cause the radio to be damaged. Stop transmitting immediately and check the following matters. If it doesn't solve the problem, please ask the dealer or Diamond Antenna Corporation.

[Condition: If the antenna doesn't seem to receive well or propagate well]

- Check 1: Is the antenna too close to the building wall? If the obstacles are too close to antenna, VSWR is higher and the radiation pattern is disturbed. Please install the antenna from the building as far away as possible.
- Check 2: Did you assemble the antenna correctly? Please read the instruction again and reconfirm the assembly.
- Check 3: Is the coaxial cable something wrong? Please check if soldering the connector is okay and the wire breaks by the volt-ohm meter.

• Antenna location

Resonate frequency of HF antenna can change based on location. Antenna should be mounted away from tree, building and other antennas.

- ① If the CP8040 is located on the roof of a house or top of a building, look around the roof to see if there are any obstacles such as TV antenna or water reservation tank. The CP8040 has to be located as far away as possible from those things to obtain its maximum performance.
- ② If the CP8040 is installed on a balcony railing, installing the antenna too close to the building wall may cause bad effect for electrical characteristics of the antenna. Locate at least 2m to 5m (7' to 16') away from the building wall depending on structure of the building.

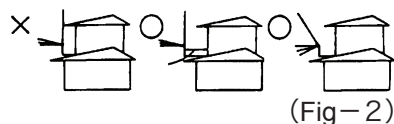

<<Note>>

- Fastening the radial element trap coil assembly tightly may be damaged.
- Install radial as much as far from building.
- In case of using the metallic stay wire, set the wire on the lower mast bracket set and attach the insulators at within 1m from the mast bracket set in order to insulate.
- It is possible to remove the radials you don't use the band for.

• 180 degrees radial

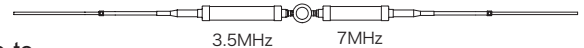

(Fig-3)

• 90 degrees radial (one directional style)

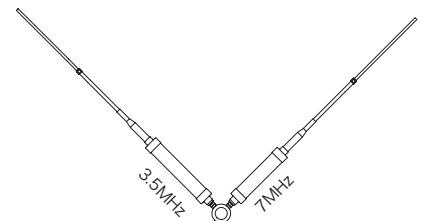

(Fig-4)

• Assembly Instruction

- ① Put radial element in each radial element trap coil assembly by referring to the typical element length listed in Table A/B and fasten it with element fastener ring. (Figure-5)
- ② Set grip nut rightly to treaded part of each radial element trap coil assembly.

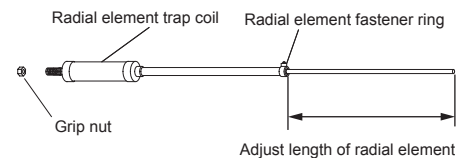

(Fig-5)

- ③ Connect vertical element parts (Pipe No. 1, No. 2, S trap, Loading coil for MHz, Pipe No. 3, No.4, No. 5) and fasten them with tapping screws and inner tooth washers by aligning holes in each joint section.
- ④ Attach two Hat and two Hat S alternately on Hat ring.

⑤ Attach mast support pipe to mast with mast brackets. Mast support pipe's tapping hole has to be placed above the brackets and it has to be pointed outside against the mast. Upper end of mast support pipe has to be placed more than 12cm(4.7') above the top end of the mast.

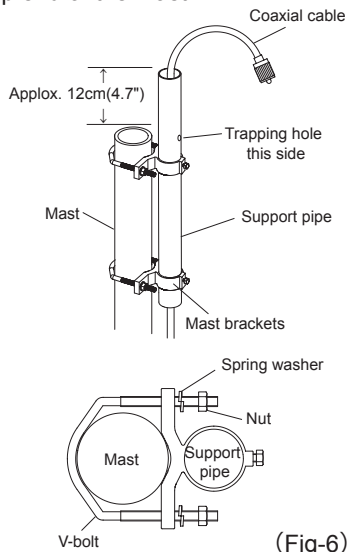

(Fig-6)

⑥ Place two radial element holders from upper end of the support pipe and fasten temporary with screwdriver. Do not fasten too tightly at this stage, otherwise feedpoint assemblies might not be put into the support mast later.

⑦ Connect a coaxial cable to feedpoint assemble through the support pipe. Then align the hole in the lower part of feedpoint assembly with the hole in the support pipe and secure them with hex head screw and spring washer.

(Note) Please do the waterproof processing to the connector section.

⑧ Place vertical element on feedpoint assembly and fix with two hex head screws and spring washers.

⑨ Turn each radial element into radial element holders. Then align water drain hole in each radial element trap coil assembly downward by turning backward and fasten each element with grip nut.

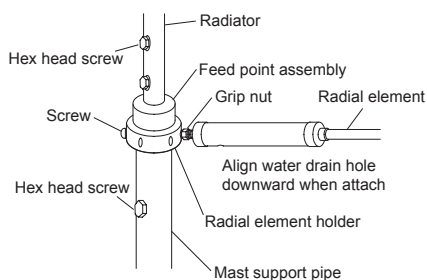

(Fig-7)

**<<Note>>**  
To avoid breaking each radial element trap coil assembly, turn it into a holder lightly till it stops and turn backward to align water drain hole downward and secure with a screw.

• Adjustment

**<<Note for frequency adjustment>>**  
Practice the following adjustment procedure at the place where the antenna is actually installed. Test transmission for the adjustment has to be performed for as short time as possible and with as low RF power as possible. Maximum RF power rating of continuous wave (CW) is about 1/3 of it in SSB mode. If the antenna is installed on a long balcony railing, the railing itself may work as a radial element and VSWR of the antenna may not be changed with the adjustment of attached radial element length. If resonant frequency of the antenna is within a desired range, the antenna can be used normally in this case. If resonant frequency is out of desired frequency range and adjustment is required, the antenna has to be isolated from the railing, moved to a different place or installed on a mast, which is at least 1m to 2m (3.3' to 6.6') long.

① Prepare suitable VSWR meter for operating frequencies and output RF power. Then connect it as shown in below.

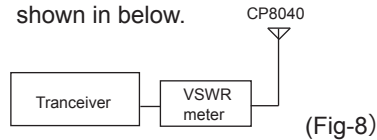

(Fig-8)

② Adjustment procedure can be started from any frequency you like. Transmit at desired frequency and trim adjustment length of radial element to have lower VSWR at the frequency.

• Adjustment length of radial element  
Adjustment length of each radial element is shown in the following table. If you do not have a VSWR meter, adjust it to a typical adjustment length. (3.55MHz/7.05MHz)

Frequency	Radial Standard Length	Variation
7MHz	Approx. 570mm (7.05MHz)	10mm/10KHz

※7.0-7.2MHz can be adjustable. (Table A)

Frequency	Radial Standard Length	Variation	Combinations
3.500-3.62MHz	Approx. 550mm (3.55MHz)	30mm/10KHz	Hatx2, HatSx2
3.68-3.72MHz	Approx. 300mm (3.68MHz)	40mm/5KHz	HatSx4
3.745-3.805MHz	Approx. 250mm (3.745MHz)	25mm/10KHz	HatSSx4

※3.500-3.805MHz can be adjustable. (Table B)

※If the radial element of a band is made longer, resonant frequency of the band is made lower proportionally.

※Though typical adjustment length of each radial element is set at center frequency of each band, it varies more or less depending on the place the antenna is installed.

Adjustment example:

If center frequency of 40m band is set at 7.050MHz and real center frequency when the antenna is installed is at 7.010MHz, then frequency difference between is 7.050MHz (desired center frequency) - 7.010MHz (real center frequency) = 40KHz.

From Table A, adjustment length at 40m band is about 10mm per 10KHz, therefore:

10mm x 40KHz / 10KHz = 40mm  
Since real center frequency is lower than desired center frequency, radial element has to be made 40mm shorter to have 7.050MHz center frequency.

• VSWR

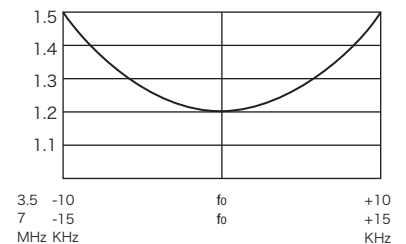

• Specifications

- Frequency range 3.500-3.805MHz
- 7.00-7.20MHz
- Feed point Impedance 50Ω
- VSWR Less than 1.5
- Maximum power rating 200W(SSB), 70W(FW/CW)
- Maximum wind resistance 35m/sec
- Vertical element length 6.53m
- Radial element length 1.8m
- Weight 4.1kg
- Connector M-J
- Mast diameter accepted 1 1/5" - 2 1/3" (30-62φ)
- Design 2 band trap vertical antenna with trap radials

Though these products purchased are manufactured under strict quality control, if damage is caused by transporting, ask your dealer promptly.

Design and specifications of these products will be changed for future improvement without advance notice.

**DIAMOND ANTENNA CORPORATION**