

BB6W

Operation Instructions



To use the antenna properly, read these instructions thoroughly before using it. Keep this manual carefully at hand for later use.

Warning

- ① The places where the antenna is installed are restricted by local state and federal law. Install the antenna at the specified and safe places.
- ② Don't touch the antenna during transmitting. It may cause to have a fire or electrify.
- ③ The thunder seems to rumble in the vicinity, don't touch the antenna and coaxial cable. It may cause to electrify.
- ④ The antenna may be struck by lightning. When you don't use the transceiver, take off the cable from the transceiver and leave the antenna under the eaves where is not easily reachable by people. It may cause to have a fire or electrify.
- ⑤ Don't install the antenna too close to electric wire, neon sign or overhead wire of trains. Don't install the antenna too close to telephone wire. When the antenna falls down, it may cause broken wire.
- ⑥ Don't work in order to install the antenna at unstable or high place.
- ⑦ Don't drop the antenna, tools and attachments, when installing the antenna in height. Install the antenna before assembling it on the ground.
- ⑧ Don't install on a rainy day or windy day since it is dangerous.

Attention

- ① SWR of the BB6W is less than 2.0 because BB6W is designed as wide band. When transmitting, use the antenna tuner and adjust the SWR less than 1.5. SWR could be changed depending on the installation situation.
- ② Ham radio wave inflicts wave obstacle on the home electric appliances or telephone equipment. Beforehand, confirm if the electronic obstacles aren't inflicted on home of your own or neighborhood. It may cause to the trouble.
- ③ Installation is restricted depending on mansion or apartment. Beforehand, confirm installation restricted to administration office.

Parts

The unit is consisted of the following parts.

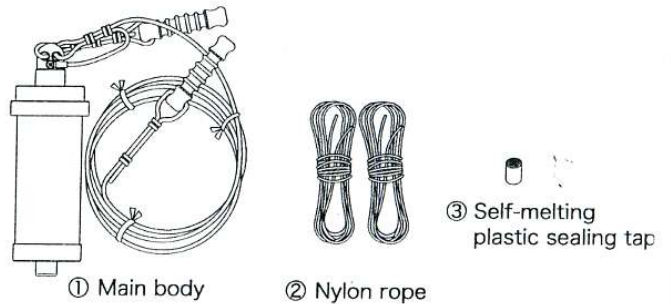

- ① Main body(Assembled) x 1
- ② Nylon rope (5m) x 2
- ③ Self-melting plastic sealing tape(30cm) x 1

Completion drawing(Parts number)

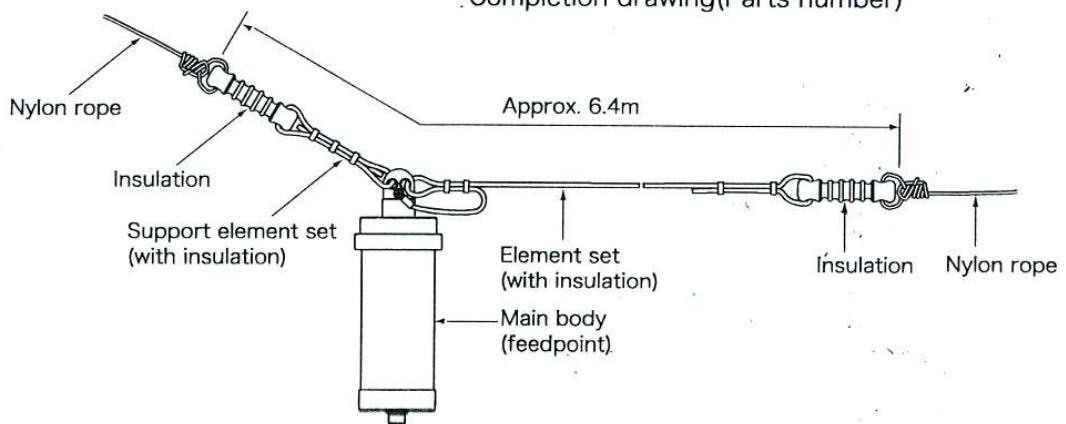

• How to install

- ① Tie the insulation at the both ends of the antenna with nylon rope. Fix the rope firmly as show in the following figure.

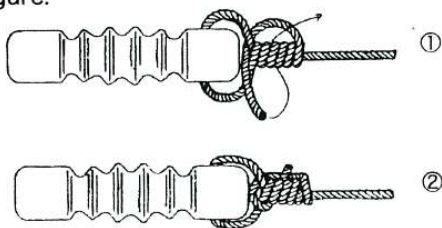

- ② HF band is strongly affected by surrounding situation. Install the antenna as far away as possible from the building or the ground. Installing the antenna either horizontally or slope is fine. If the antenna is installed between two trees, to avoid breaking the element by strong wind, it is recommended to put elastic material such as rubber band or coil spring at the both ends of the elements. Don't install the antenna too tightly. It is recommended the antenna with some allowance. (Note) The characters of the antenna may be changed depending on the installation situation.

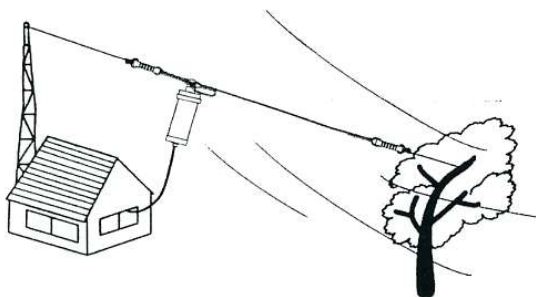

- ③ Connect the coaxial cable to the feedpoint of the main body. To make connector section waterproof, wrap around self-melting plastic sealing tape supplied by stretching it about 1.5 times. Then wrap around conventional plastic tape to ensure it.

• Confirming SWR

- ① BB6W is a non-adjustable antenna but SWR is higher depending on the surround situation. Use the antenna tuner, to make SWR less than 1.5.
- ② Practice test transmission for the adjustment as short time and least RF power as possible.
- ③ Prepare a VSWR power meter for applicable frequencies and RF power, and set the meter as shown in the above figure.

Example 1
(Transceiver without the antenna tuner)

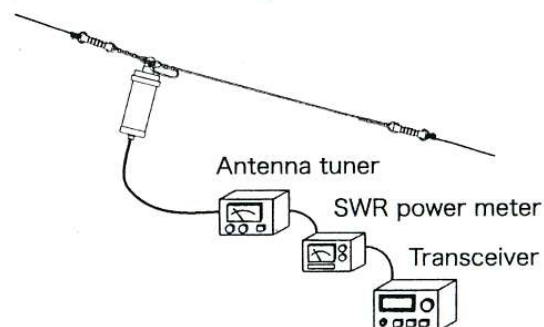

Example 2
(Transceiver with internal automatic antenna tuner)

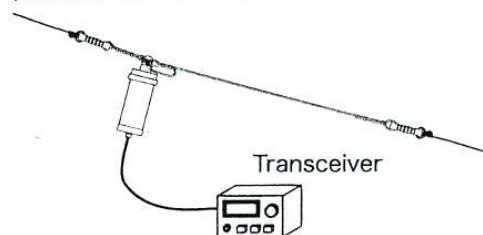

- When SWR is too high
Since the antenna is affected by building or the ground, change the installation place or height.

• VSWR

*The characters of the antenna may be changed depending on the installing situation without the antenna tuner.

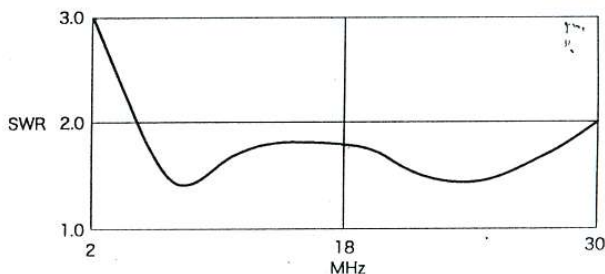

• Specification

Frequency	2-30MHz (with antenna tuner)
Impedance	50Ω
VSWR	Less than 2.0 (3-30MHz)
Max Power Rating	250W (PEP)
Connector	M-J
Length	Approx. 6.4m
Weight	0.8Kg(with antenna wire)

- Though the product being purchased is manufactured under strict quality control, if damage is caused by transporting, ask your dealer promptly.
- Design and specification of these products will be changed for future improvement without advance notice.

DIAMOND ANTENNA CORPORATION

Miyata Building, No.15-1, 1-chome, Sugamo Toshima-ku, Tokyo 170-0002, Japan Phone:(03) 3947-1411 Fax:(03) 3944-2981
<http://www.diamond-ant.co.jp/english.html> E-MAIL : overseas@diamond-ant.co.jp